

# ACE<sup>®</sup>

## HPLC and UHPLC Columns Product Catalogue

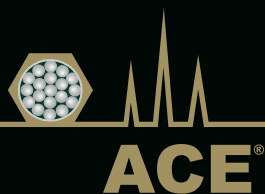

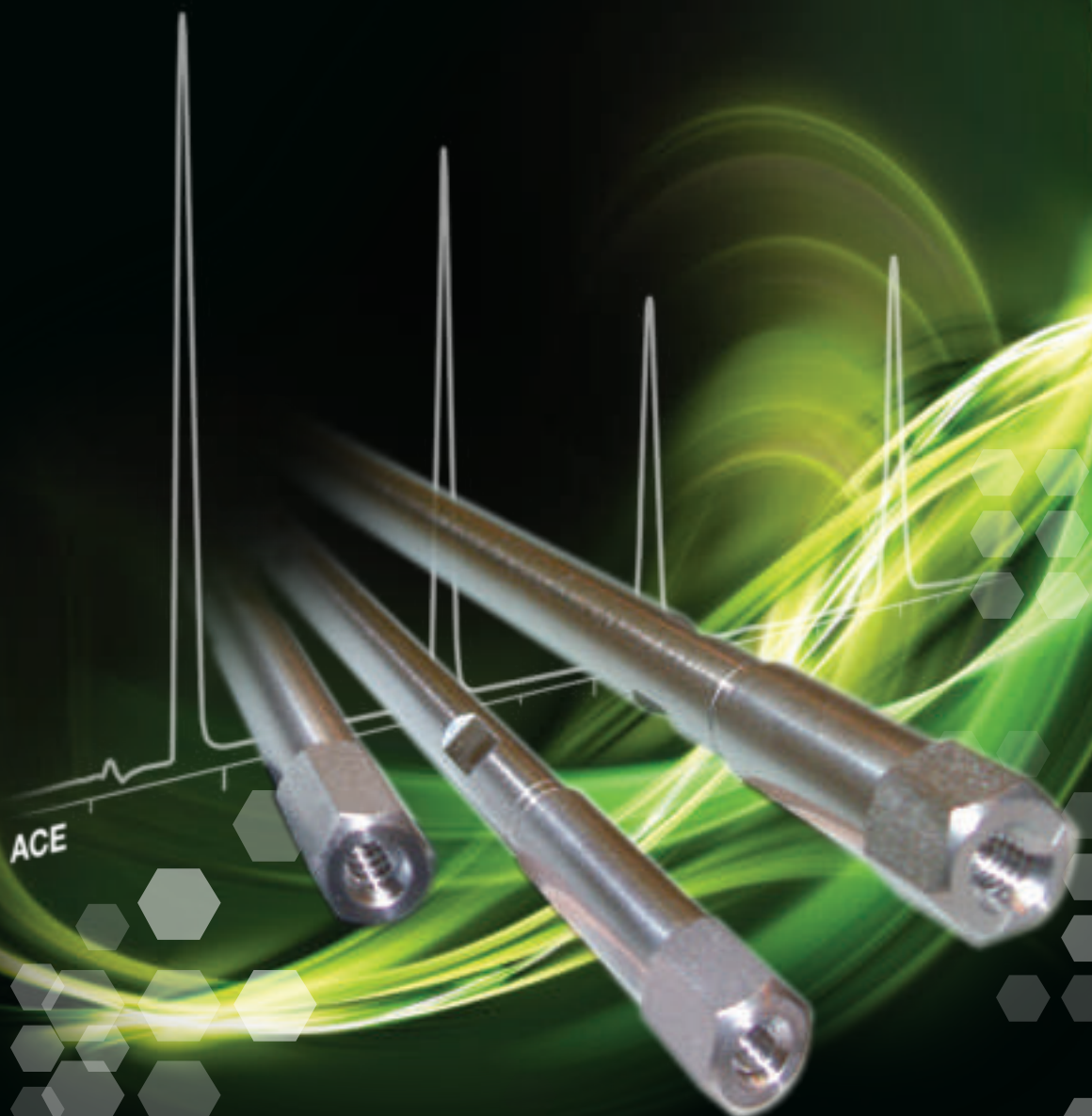



Ultra-Inert, Base Deactivated  
HPLC & UHPLC Columns

## ACE Ultra-Inert, Base Deactivated HPLC and ACE Excel UHPLC columns give you the choices you need to achieve successful separations.

### 10 PHASES

C18 | C18-AR | C18-PFP  
C18-HL | AQ | C8 | C4 | Phenyl  
CN | SILCA

Leverage 5 different mechanisms of separation offered by these bonded phases to achieve optimum selectivity for all peak pairs in your sample.

### 3 PORE SIZES

90Å | 100Å | 300Å

Match the stationary phase support to the molecular size of your analytes. For peptides and proteins, choose a 300Å pore. For molecules smaller than 5,000 daltons, choose 100Å pore. Plus, optimize your column's hydrophobic strength and loading capacity for your particular separation needs. The 90Å pore C18-HL stationary phase offers greater surface area for higher loading capacity.

### 5 PARTICLE SIZES

2 µm | 3 µm | 5 µm | 10 µm  
15 µm

Choose the right particle size for UHPLC, HPLC or preparative HPLC.

### 11 STANDARD COLUMN LENGTHS

300 mm | 250 mm | 200 mm  
150 mm | 125 mm | 100 mm  
75 mm | 50 mm | 35 mm  
30 mm | 20 mm

Find the right balance between analysis time, resolution and peak capacity. Enquire for lengths not listed.

### 12 STANDARD COLUMN IDS

0.075 mm | 0.10 mm | 0.30 mm  
0.50 mm | 1.0 mm | 2.1 mm  
3.0 mm | 4.0 mm | 4.6 mm  
10.0 mm | 21.2 mm | 30.0 mm

Enjoy ACE performance from capillary to preparative applications.



# Table of Contents

## 1: How to choose the right HPLC or UHPLC column

Will the column separate the analytes in my sample? _____	6
Will the column provide good peak shape for my analytes? _____	8
Will the column deliver the separation speed needed? _____	9
Will the column be reliable and have long-lasting performance with my chromatographic conditions? _____	10
Will the column provide reproducible chromatography from column-to-column and batch-to-batch? _____	12
Will the column allow for easy transfer of methods from HPLC to UHPLC, or vice versa? And, will the column provide easy scalability to preparative HPLC? _____	13

## 2: ACE Bonded Phases

C18 _____	16
C18-HL _____	18
C18-AR _____	19
C18-PFP _____	20
C8 & C4 _____	22
Phenyl & CN _____	23
AQ _____	24

## 3: ACE Column Configurations

ACE Excel UHPLC Columns _____	28
300Å Columns for Peptides and Proteins _____	30
Capillary & Nano Columns _____	34
Preparative HPLC Columns _____	35
Guard Columns _____	36
Pre-Column Filters _____	37
Ordering Information _____	38





CHAPTER

**1**

| How to choose the right HPLC or UHPLC column for your needs.

**Choosing the best HPLC or UHPLC column for a separation generally means finding a column that you can answer “yes” to several crucial questions.**

# Q

## Will the column separate the analytes in my sample?

# A

Leverage the power of stationary phase selectivity with ACE bonded phases.

$$R_s = \frac{\sqrt{N}}{4} \left( \frac{\alpha - 1}{\alpha} \right) \left( \frac{k}{1 + k} \right)$$

The resolution equation identifies the parameters that contribute to resolution: efficiency (N), retention (k) and selectivity ( $\alpha$ ). There has been a great deal of emphasis in the past several years on column efficiency and the use of ultra-efficient columns, so called “UHPLC” columns, as a means of achieving separation goals. UHPLC has proved its value by contributing to improvements in laboratory productivity through faster separations and faster method development. However, selectivity is often overlooked and its importance overshadowed by the emphasis on column efficiency. This is unfortunate. Of the three parameters that affect resolution, selectivity is the most powerful. (See Figure 1) By leveraging both efficiency and selectivity, better and faster separations often can be achieved.

**FIGURE 1: The effect of N,  $\alpha$  and k on resolution ( $R_s$ )**

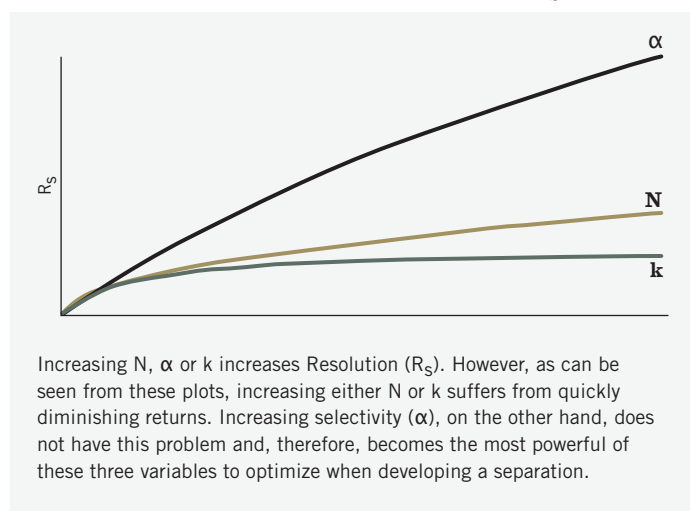

In reversed-phase chromatography, there are multiple mechanisms of interaction between the stationary phase and analytes that can be leveraged to achieve a separation. These mechanisms of interaction include: hydrophobic binding,  $\pi$ - $\pi$ , hydrogen bonding, dipole-dipole, and shape selectivity. Different types of bonded phases will offer one or more of these mechanisms of interaction. Table 1 lists ACE bonded phases and the principal mechanisms of interaction that are possible with each, depending on the analyte and the mobile phase conditions.

**TABLE 1: Comparison of separation mechanisms/interactions offered by different bonded phases**

ACE Bonded Phase	Hydrophobic Binding	$\pi$ - $\pi$	Hydrogen Bonding	Dipole-Dipole	Shape Selectivity
C18	Strong	None	None	None	Weak
C18-HL	Very strong	None	None	None	Weak
C18-AR	Strong	Strong	Moderate	Moderate	Moderate
C18-PFP	Strong	Strong	Strong	Strong	Strong
AQ	Moderate	None	Moderate	Weak	None
C8	Moderate	None	None	None	None
C4	Weak	None	None	None	None
Phenyl	Moderate	Strong	Weak	Moderate	Weak
CN	Weak	None	Weak	Strong	None

### Leverage bonded phase selectivity to achieve better separations.

Figure 2 illustrates the selectivity difference between two ACE bonded phases, the C18-AR and the Phenyl. Although both bonded phases offer the possibility of strong  $\pi$ - $\pi$  and dipole-dipole interactions, they differ significantly in the strength of other possible mechanisms of interaction, particularly hydrophobic binding. The additional, or different, mechanisms of separation that are possible with the C18-AR yield a better overall separation for this complex mixture. For other mixtures, this may not be the case and that’s the advantage of the ACE bonded phases. ACE bonded phases provide a wide variety of powerful retention mechanisms to choose from when developing separations. The extremely powerful and unique C18-AR and C18-PFP phases are only available in ACE and ACE Excel columns.

By leveraging both efficiency and selectivity, much better separations can be achieved.



**FIGURE 2: Comparison of Selectivity Differences Between C18-AR and Phenyl Phases**

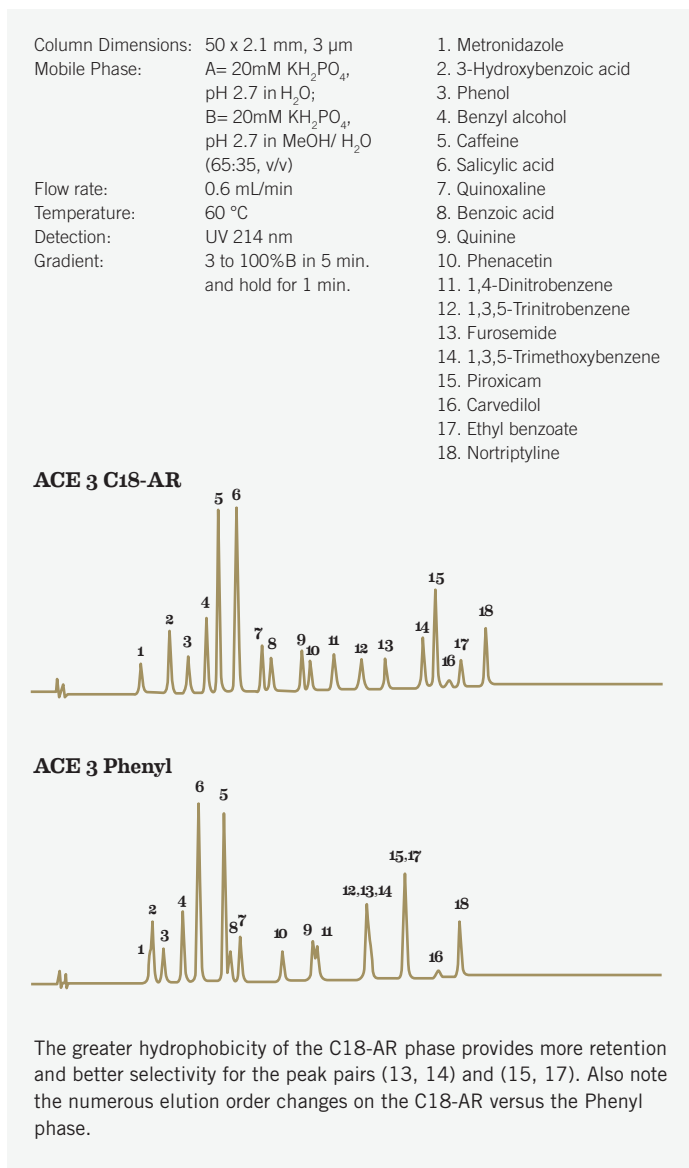
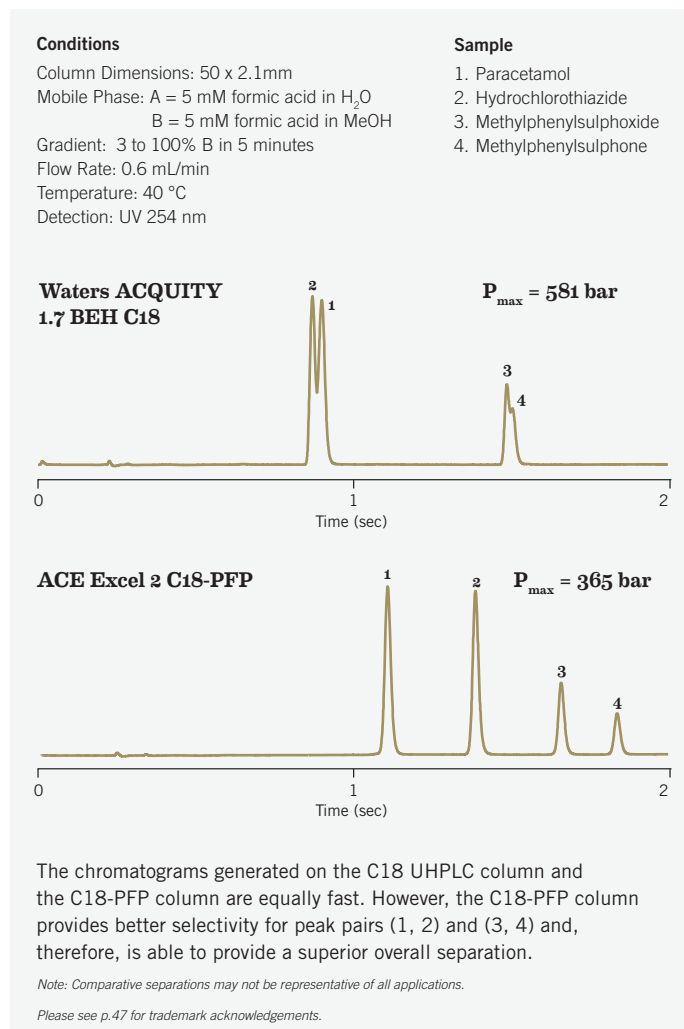

Figure 3 provides another illustration of the power of bonded-phase selectivity. One separation was done on a UHPLC column packed with a C18 bonded phase and the other separation was done on a UHPLC column packed with a C18-PFP bonded phase. The additional mechanisms of separation offered by the C18-PFP bonded phase generates a better overall separation.

**FIGURE 3: ACE Excel delivers excellent resolution and peak shape: Pharmaceuticals and Related Compounds by UHPLC**



# Q

## Will the column provide good peak shape for my analytes?

# A

ACE and ACE Excel silica-based stationary phases have virtually eliminated the negative effects of silanols on chromatographic separations and have earned a well deserved reputation for delivering excellent peak shape for basic compounds.

Peak tailing can reduce resolution, decrease sensitivity and even interfere with accuracy and precision (Figure 4). There are many potential causes of peak tailing, but the primary cause when separating bases is the interactions between acidic silanols on the surface of the silica stationary phase support particles and amine groups on analytes (Figure 5).

**FIGURE 4: Effect of peak tailing on resolution and sensitivity**

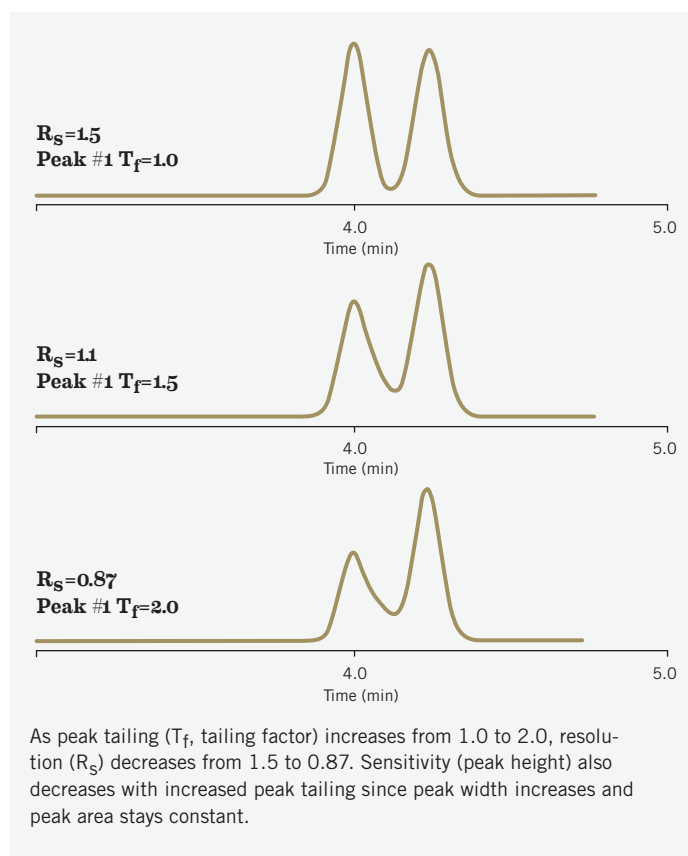

ACE columns are manufactured using ultra-pure silica that has extremely low silanol activity. This ultra-pure silica is efficiently bonded and exhaustively end-capped using proprietary technology. The result is a silica-based stationary phase that has virtually eliminated the negative effects of silanols on chromatographic separations. The ultra-inert characteristics of the ACE columns make them the ideal choice for separating polar basic compounds. When compared to other modern base-deactivated columns, ACE columns consistently produce measurably better peak shape and column efficiency when separating troublesome basic compounds (Figure 6).

**FIGURE 5: Peak tailing interaction**

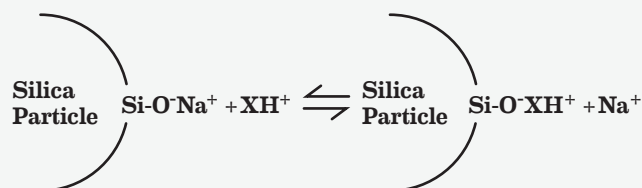

Acidic silanols on the surface of silica stationary phase supports can form ion-exchange sites that interact with basic compounds. This ion-exchange interaction will often contribute to peak retention (secondary retention) and cause peak tailing when separating amines by reversed phase HPLC.



A silica-based stationary phase that has virtually eliminated the negative effects of silanols on chromatographic separations.

**FIGURE 6: Comparison of peak tailing**

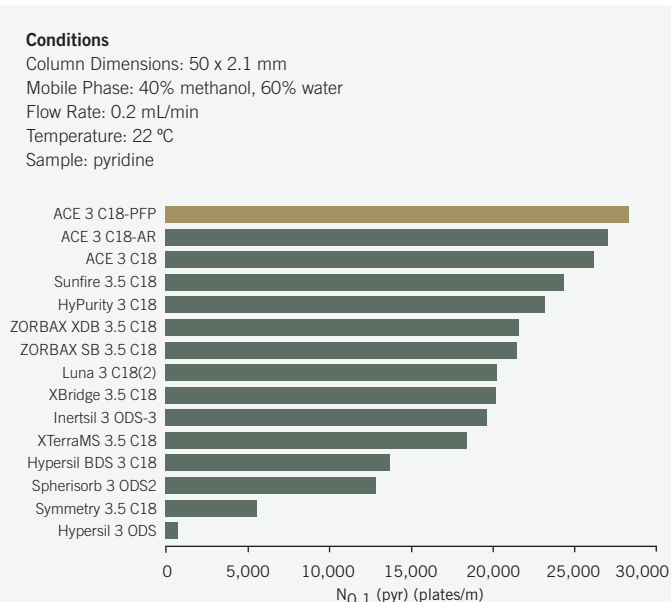

Column plate count is reported for a basic compound (pyridine) on various popular C18 columns. Plate count was measured at 10% peak height so that peak tailing is included in the measurement. The ACE C18-PFP delivered the highest plate count due to its ultra-inert nature.

*The comparative data presented here may not be representative for all applications.*

*Please see p.47 for trademark acknowledgements.*

Q

## Will the column deliver the separation speed needed?

A

## ACE Excel brings renowned ACE HPLC performance to UHPLC

It is important to recognize that column selectivity and column efficiency are independent variables and you do not have to choose to use one rather than the other when developing a separation. In fact, for the best overall separation you should optimize both, as well as retention. This is especially true when there is a need for a high speed separation. (See Figure 7)

**FIGURE 7: Utilizing both column efficiency and bonded phase selectivity to develop a faster separation**

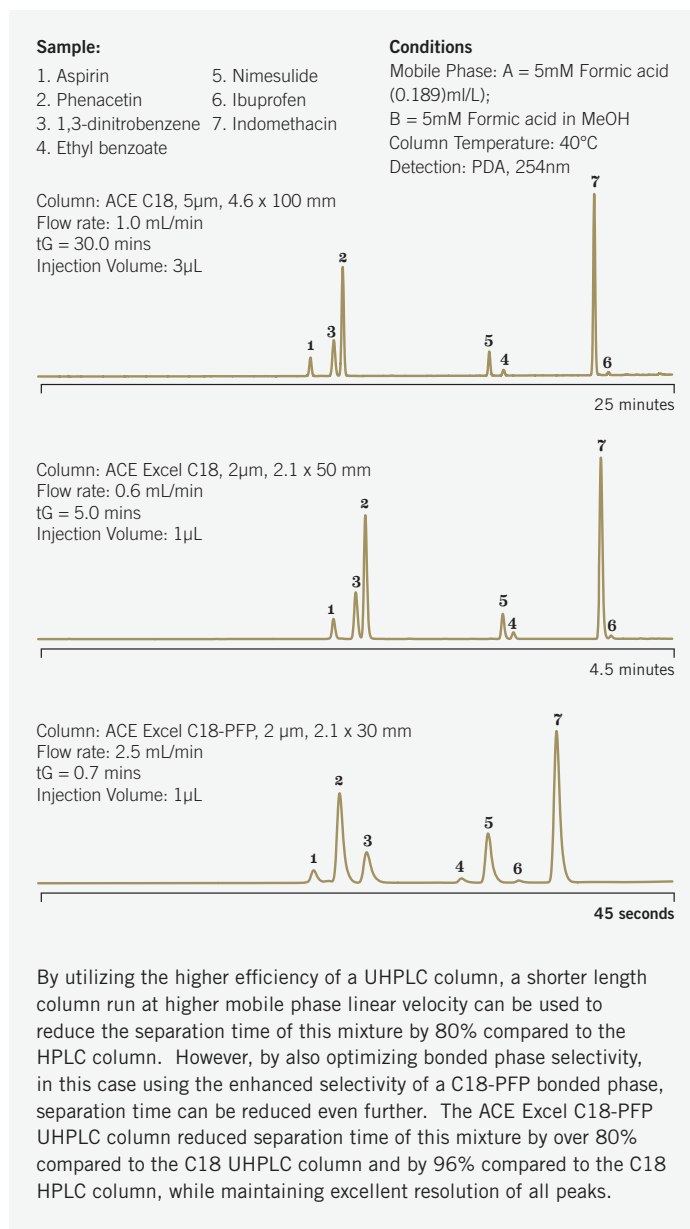

ACE Excel UHPLC columns are engineered to take full advantage of low dispersion, ultra-high pressure UPLC® and UHPLC instruments (up to 1000 bar) and are designed to be compatible with all commercially available UPLC and UHPLC systems.

ACE Excel UHPLC columns deliver better peak shape for basic compounds, improved column-to-column reproducibility, additional stationary phases that leverage multiple mechanisms of separations, and improved column ruggedness. The availability of ACE Excel UHPLC columns means chromatographers now have more choices to achieve better outcomes with their UPLC and UHPLC instruments.

**FIGURE 8: ACE Excel columns provide high-speed, high-resolution separations**

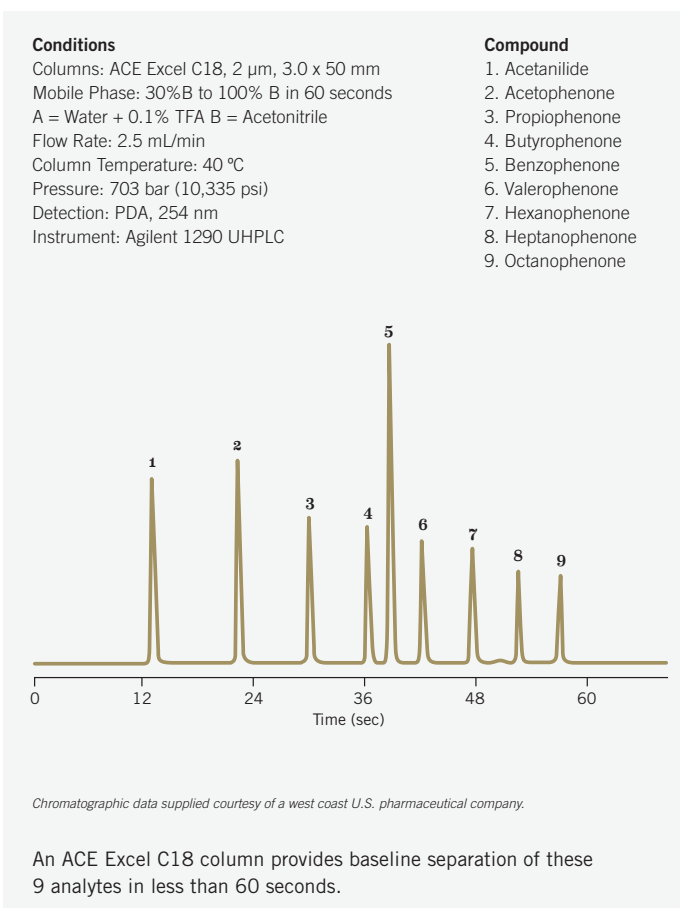

Please see p.47 for trademark acknowledgements.

# Q

## Will the column be reliable and have long-lasting performance with my chromatographic conditions?

# A

ACE HPLC columns and ACE Excel UHPLC columns have proven rugged, reliable day-to-day performance and exceptional column lifetime.

The lifetime of a column can be reduced by loss of bonded phase through acid hydrolysis of the siloxane bond to the silica stationary phase support. This acid hydrolysis increases with decreasing mobile phase pH and increasing column temperature. Shorter alkyl phases, such as C4 and C3, and phenyl phases are generally more vulnerable to loss of bonded phase than are C18 phases. In addition, lower purity silica stationary phase supports and lower coverage of the surface of the stationary phase support makes some bonded phases even more vulnerable to acid hydrolysis.

ACE bonded phases exhibit exceptionally high stability due to the use of ultra high purity silica stationary support particles combined with unusually high surface coverage by the bonded phase. (See Figure 9)

In spite of the exemplary stability of all ACE bonded phases, some bonded phases are just not as stable as others. For example, C18 bonded phases are generally considered to be more stable than shorter length alkyl phases, PFP phases and phenyl bonded phases. In fact, the poorer stability of typical phenyl phases is one of the main reasons that this phase has not been chosen more often for method development. The ACE C18-AR was developed to solve this problem

and permits chromatographers to take advantage of the strong  $\pi$ - $\pi$  and dipole-dipole mechanisms of separation and still enjoy the ruggedness and durability of a C18 phase. As Figure 10 demonstrates, the ACE C18-AR not only has much superior stability to typical phenyl bonded phases, it even shows better stability than many other C18 bonded phases. Similarly, the ACE C18-PFP offers multiple mechanisms of separation that can be leveraged to achieve a better overall separation while benefiting from the stability of a C18 phase.

**FIGURE 9: Acid Stability, pH 1.8**

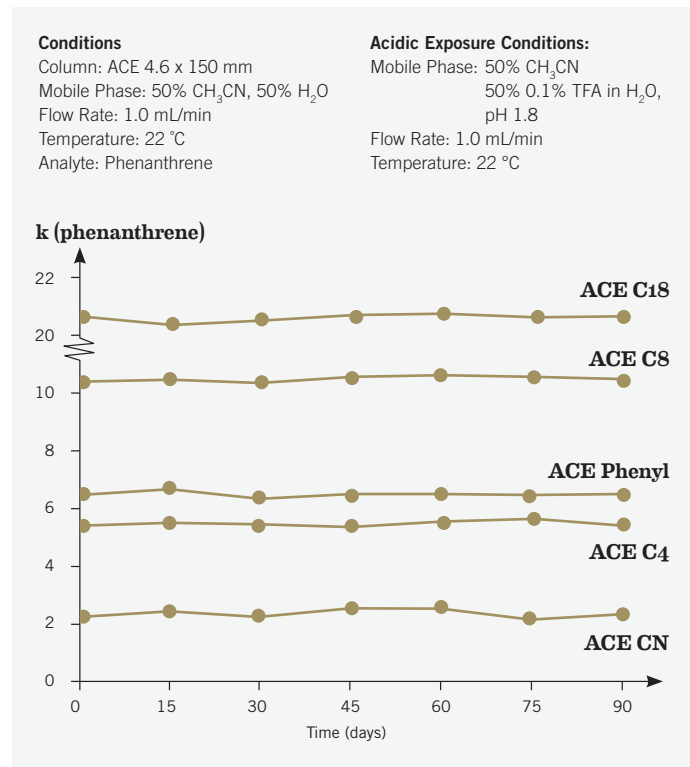

**FIGURE 10: Accelerated Column Stability Study: 80° C at pH 1.9**

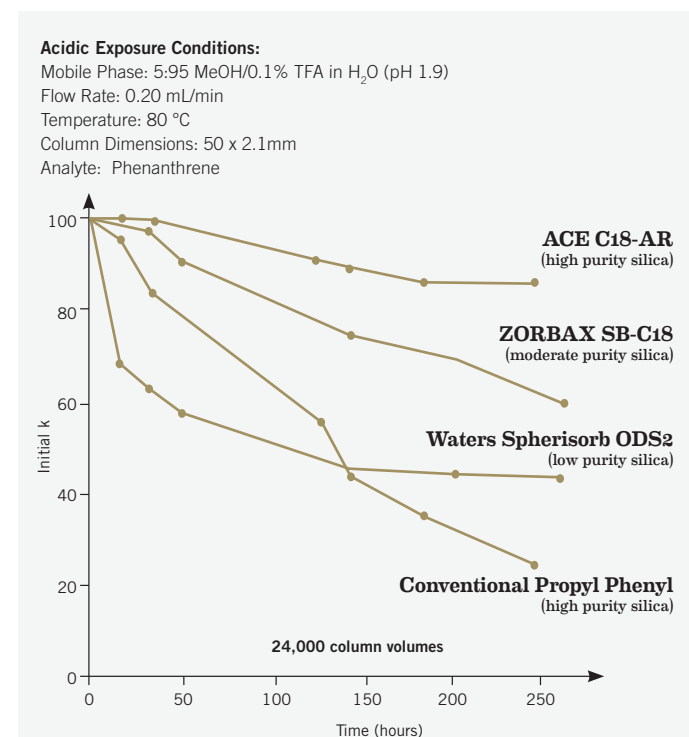

Using conditions designed to accelerate column degradation, ACE C18-AR phase shows little retention loss, with lifetime equivalent to the highly robust ACE C18 phase. Both phases are manufactured from the same ultra pure silica, and outlast the Zorbax SB-C18, a phase previously recognized to provide excellent stability for high temperature and low pH applications.

As expected, a C18 bonded column based upon a low purity silica (Waters Spherisorb ODS2) shows a greatly reduced lifetime under these accelerated conditions.

Of particular note is the result comparing the lifetime of a conventional phenyl column to ACE C18-AR. Despite the use of a high purity silica, the lifetime of the phenyl column is diminished compared with ACE C18-AR, suggesting that ACE C18-AR may be suitable for applications in which propyl phenyl columns are seen to exhibit reduced lifetime.

*The comparative data presented here may not be representative for all applications. Please see p.47 for trademark acknowledgements.*

Interfacing HPLC and UHPLC to mass spectrometers, generally referred to as LC-MS, has become commonplace. However, mass spectrometry is sensitive to even subtle amounts of bonded phase that may elute from an HPLC/UHPLC column, so called column “bleed”. Column bleed can interfere with analytical results and it is important that columns chosen for LC-MS applications have bonded phases stable enough to avoid excess bleed. Figure 11 demonstrates that the ACE C18-PFP column has very little “bleed” to interfere with LC-MS analyses. The stability of the C18-PFP (and also the ACE C18 and ACE C18-AR) make these columns much more suitable for LC-MS applications.

**FIGURE 11: The low column bleed for ACE C18-PFP columns makes them ideal for LC/MS applications**

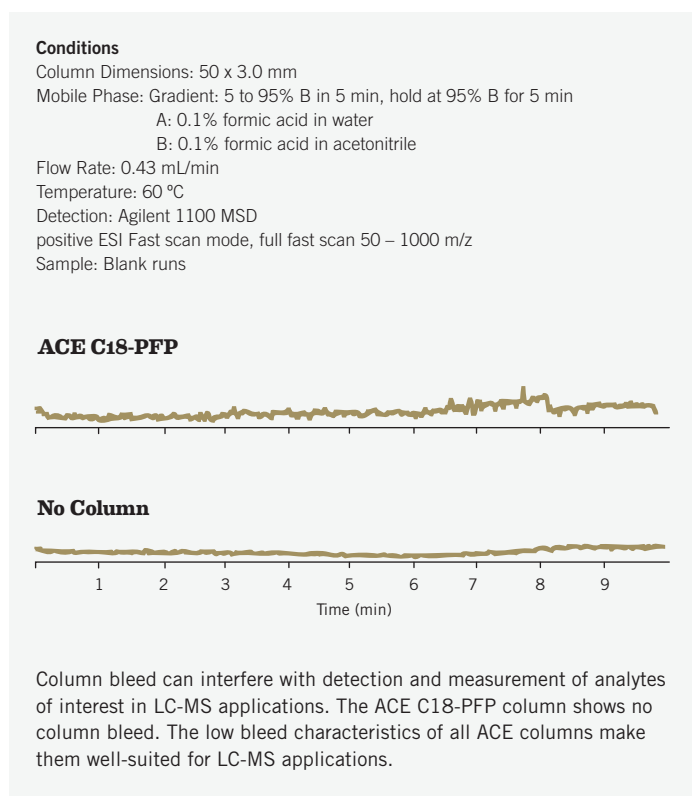

UHPLC columns can suffer from a lack of durability. Add to this the possibility of inlet frit plugging and you are faced with columns that may be less durable than HPLC columns.

**ACE Excel columns are very forgiving and provide the same durability and lifetime that you would expect from HPLC columns.**

ACE Excel will change your perception about the durability of UHPLC columns. Not only are the ACE Excel columns packed better, they incorporate a proprietary inlet frit design that is much less prone to plugging than other UHPLC columns. It is still recommended that you filter samples and mobile phases as you would with any UHPLC column, but ACE Excel columns are much more forgiving than other UHPLC columns and provide the same durability and lifetime that you would expect from HPLC columns.

**FIGURE 12: ACE Excel columns have a well deserved reputation for durability**

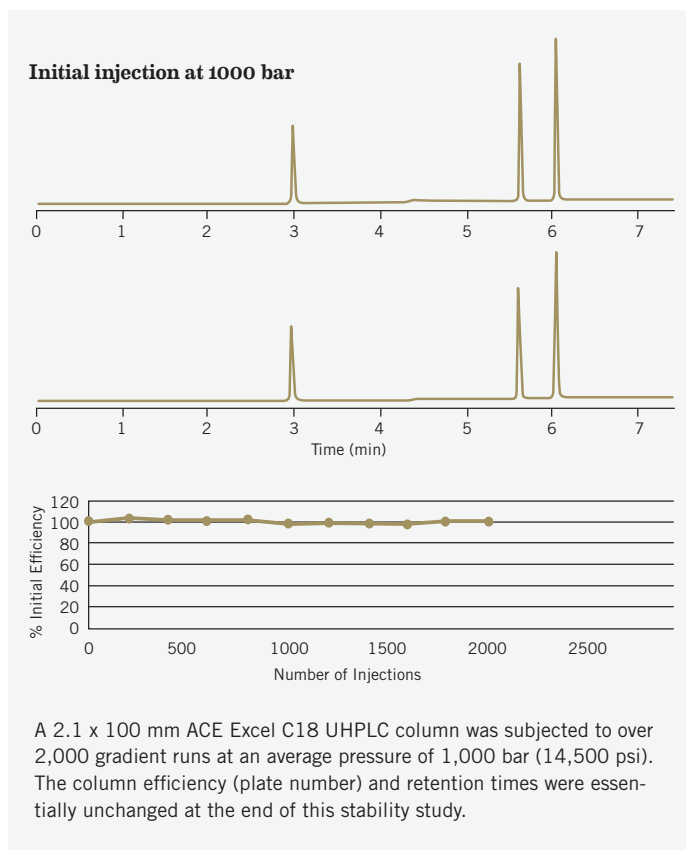

# Q

**Will the column provide reproducible chromatography from column-to-column and batch-to-batch?**

# A

ACE columns have a well-deserved reputation for reproducibility.

Column-to-column reproducibility is affected by the production of the silica stationary phase support, the bonding of the stationary phase to the stationary phase support, and the packing of the stationary phase into the column. The better each stage of the column manufacturing process is controlled, the better will be the reproducibility and the quality of the column.

ACE columns are subjected to extensive controls at each stage of the column manufacturing process. These controls ensure that ACE columns produce reliable, predictable performance from column-to-column and lot-to-lot. Figure 13 provides an example of a typical Batch Validation test.

Subtle changes in silanol activity are one of the primary causes of column-to-column selectivity changes. ACE and ACE Excel columns have excellent reproducibility due to the use of ultra pure reagents and strict control of the manufacturing process that results in a high purity silica stationary phase support with uniform surface characteristics. Combining this high purity silica with advanced bonding techniques results in a family of highly inert phases that provide an outstanding level of column-to-column reproducibility by virtually eliminating silanol interference in the chromatography.

**FIGURE 13:** Example of a batch validation report for an ACE column

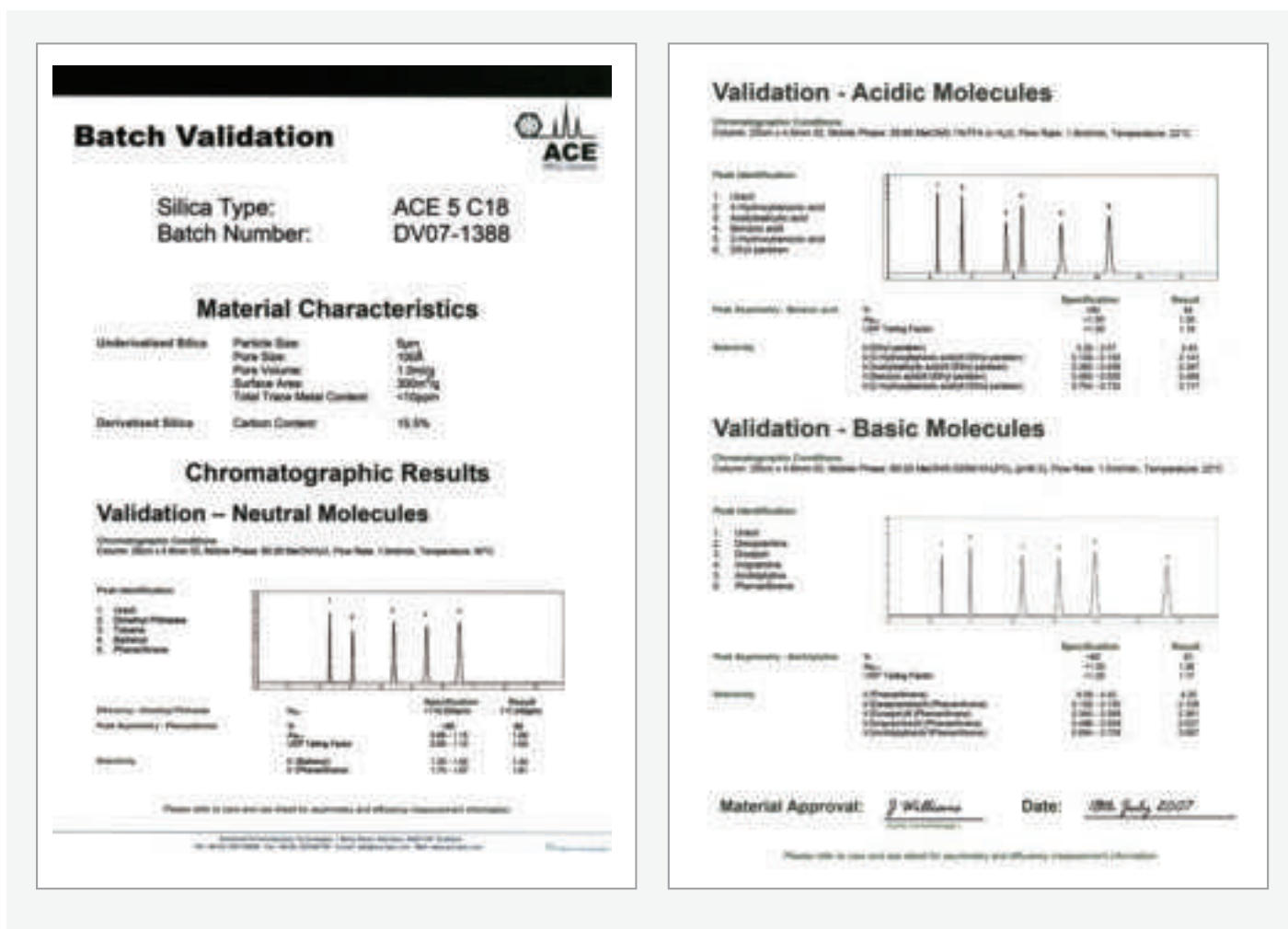

Q

Will the column allow for easy transfer of methods from HPLC to UHPLC, or vice versa? And, will the column provide easy scalability to preparative HPLC?

A

ACE columns offer easy scalability from UHPLC to HPLC to preparative HPLC.

The same controls that ensure highly reproducible columns from lot-to-lot also ensure that you can more easily transfer methods between UHPLC and HPLC, or scale up to preparative applications, when needed, to isolate or purify a target compound. The column efficiency may, of course, change, but the band spacing (selectivity) will be predictably the same. Figure 14 illustrates the type of consistent band spacing of analytes (selectivity) that can be expected when operating with the same ACE bonded phase, but with columns packed with different particle sizes.

**FIGURE 14: Selectivity is preserved and assured when scaling ACE stationary phases from UHPLC (2 $\mu$ m) to HPLC (3 $\mu$ m and 5 $\mu$ m) to preparative HPLC (10 $\mu$ m)**

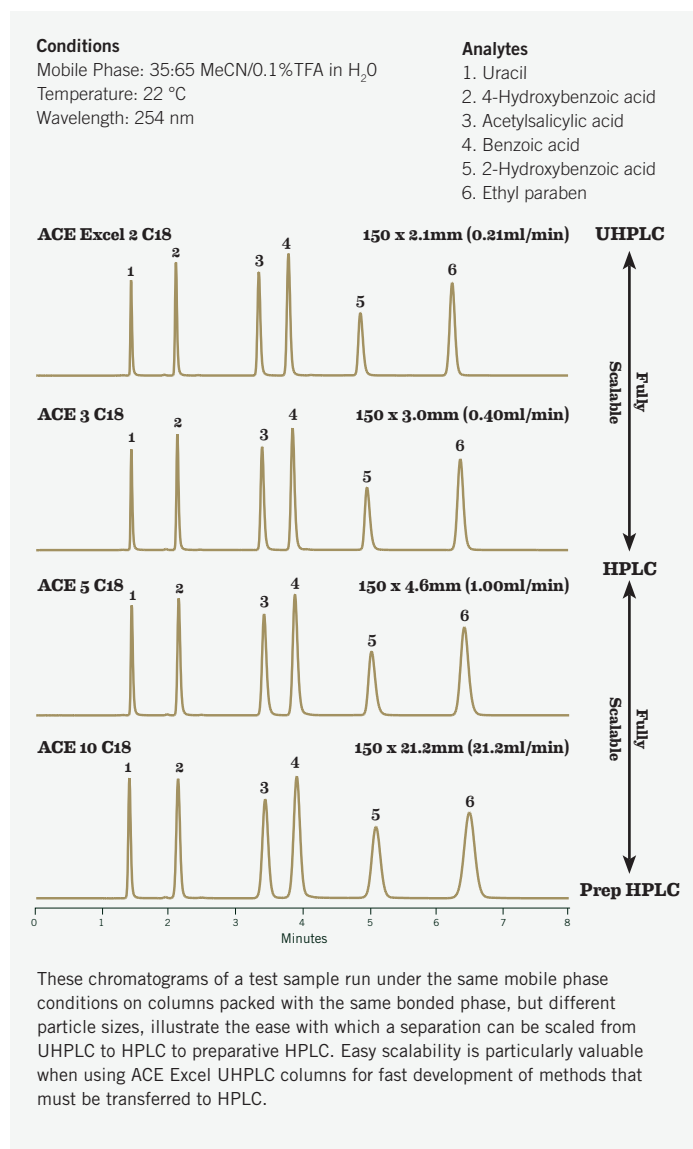

**FIGURE 15: ACE stationary phases provide the identical selectivity whether they are UHPLC, HPLC or preparative HPLC columns**

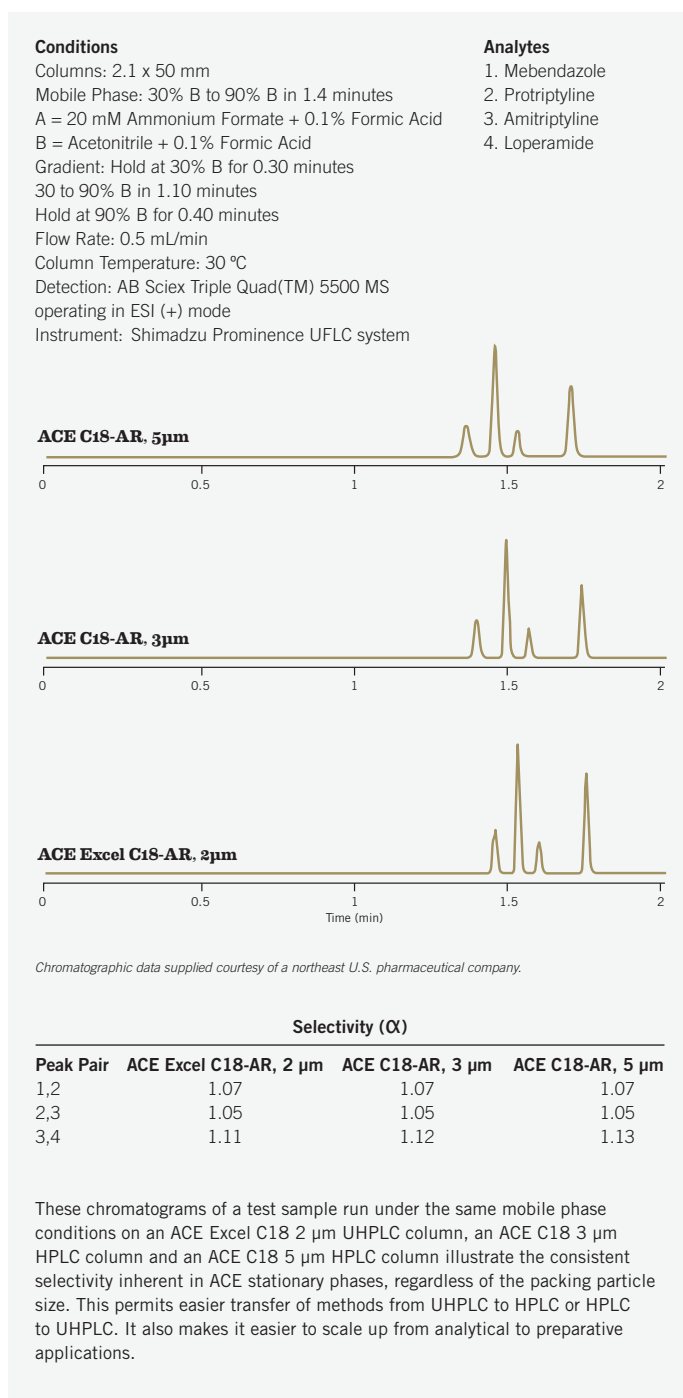

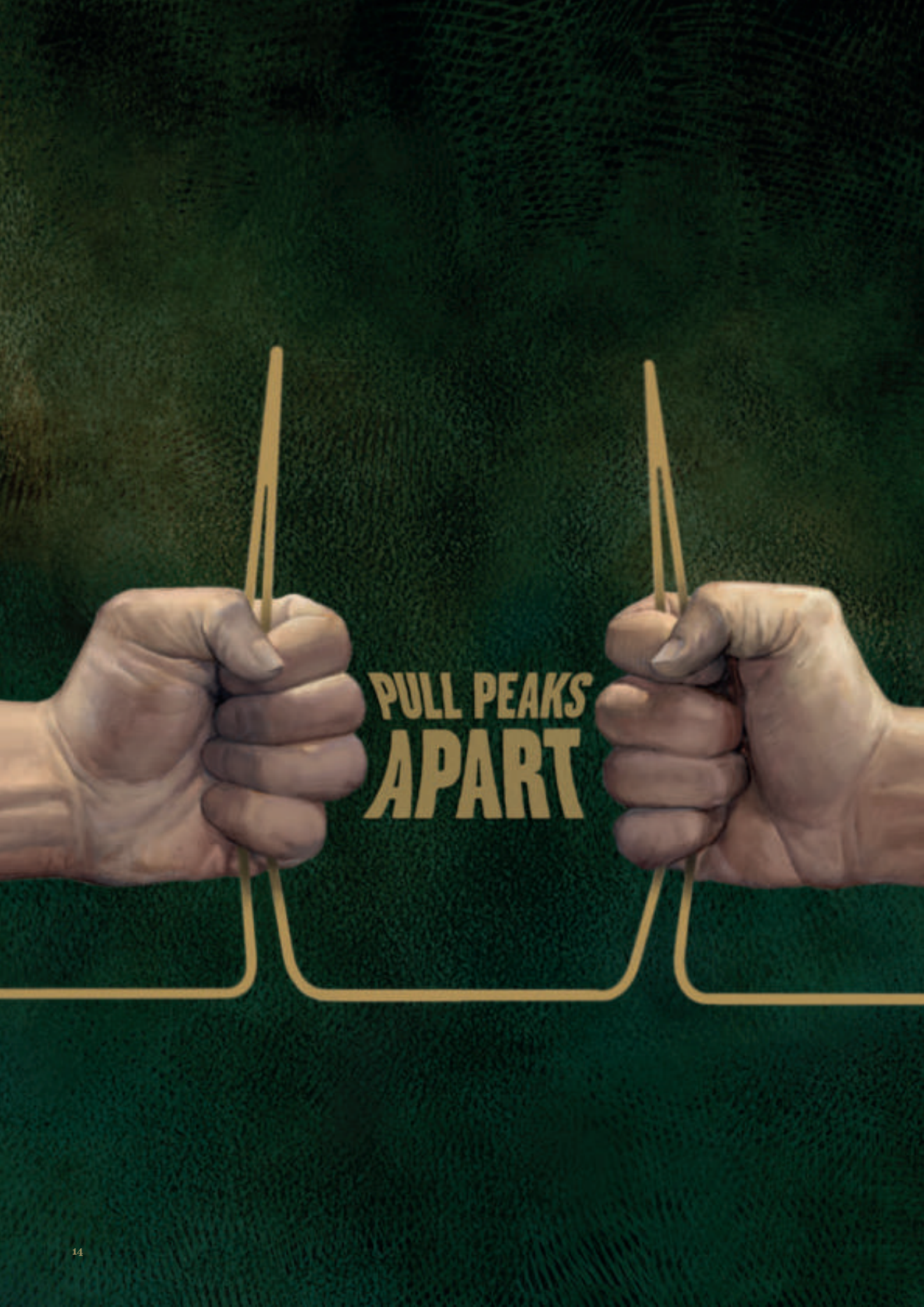

**PULL PEAKS  
APART**



CHAPTER

2

## ACE Bonded Phases.

**Leverage the power of stationary phase selectivity to pull peaks apart.**

# C18

## Mechanisms of Separation

Hydrophobic binding interactions

## Strength of Interaction

Strong

Shape selectivity

Weak

## Target Analytes

Analytes differing in hydrophobicity

Polar, moderately polar, and non-polar analytes

Uncharged acids and bases

Ionized acids or bases using ion-pairing

## Recommended Applications

Analytes differing in hydrophobicity

Homologous compounds differing by  $-CH_2$

**FIGURE 16: Pesticides in Water**

### Conditions

Column: ACE 3 C18, 150 x 2.1mm  
 Part Number: ACE-111-1502  
 Mobile Phase: A: 0.1M  $CH_3COONH_4$   
 B: MeCN  
 Flow Rate: 0.3 mL/min  
 Gradient: T(mins) %A %B  
 0 90 10  
 40 20 80  
 47 10 90  
 49 90 10  
 Temperature: 40° C  
 Detection: UV, 220nm (pendimethalin at 245nm)  
 Injection Volume: 25µl  
 Sample: 0.05µg/l standards in 10:90 MeCN/H<sub>2</sub>O

### Compounds

1. Desisopropylatrazine
2. Desethylatrazine
3. Simazine
4. Cyanazine
5. Atrazine
6. Internal standard
7. Sebuthylazine
8. Propazine
9. Terbutylazine
10. Prometryn
11. Terbutryn
12. Alachlor
13. Pendimethalin

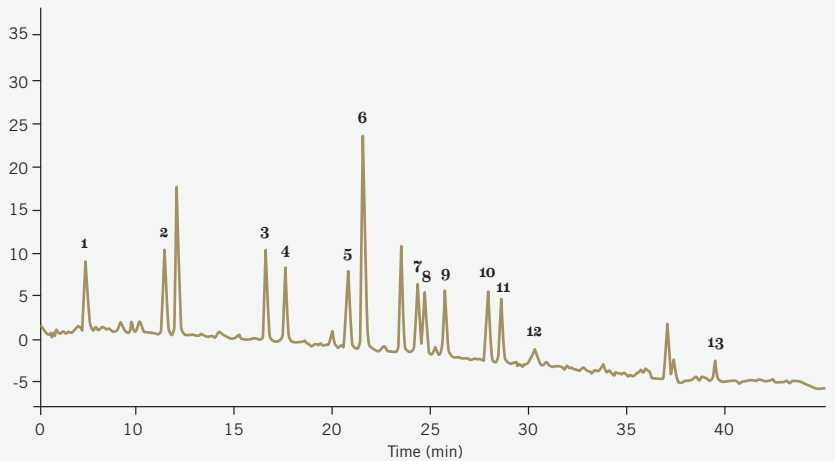

Reproduced with kind permission of Amt der Tiroler Landesregierung, Chemisch-technische Umweltschutzanstalt, Innsbruck, Austria.

**FIGURE 17: Antihistamines and Expectorants**

### Conditions

Column: ACE 5 C18, 150 x 4.6mm  
 Mobile Phase: 45:55 MeOH/20mM  $KH_2PO_4$  (pH 3.0)  
 Flow Rate: 1.0 mL/min  
 Temperature: Ambient  
 Detection: UV, 220nm  
 Injection Volume: 0.4µl

### Compounds

1. Maleic acid
2. Salicylamide
3. Guaifenesin
4. Guaiacol
5. Chlorpheniramine maleate
6. Dextromethorphan

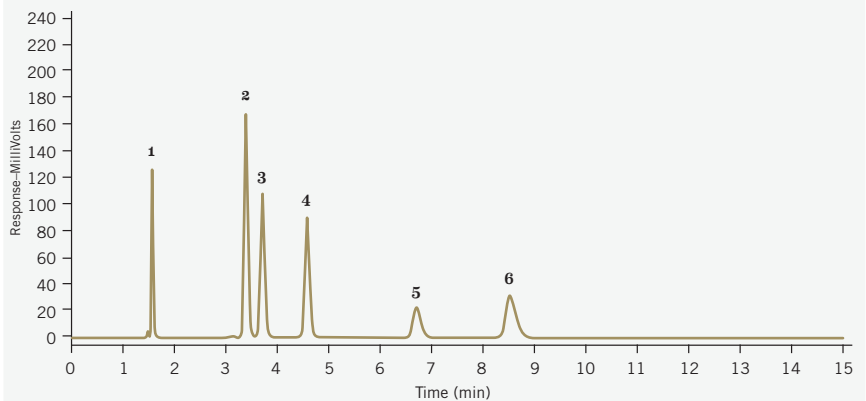

**FIGURE 18: Ibuprofen and Related Impurities**

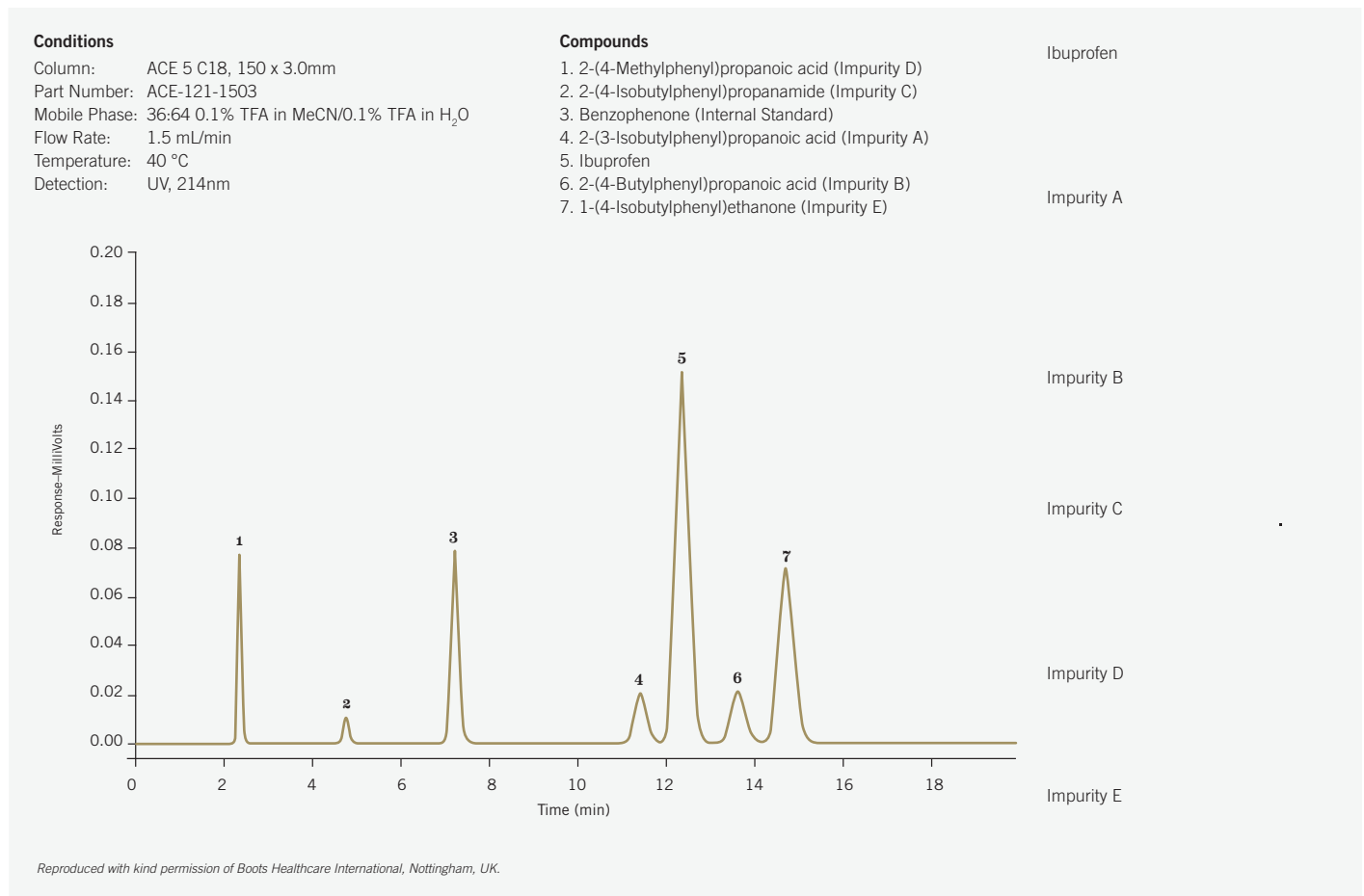

**FIGURE 19: Tryptic Digest of BSA**

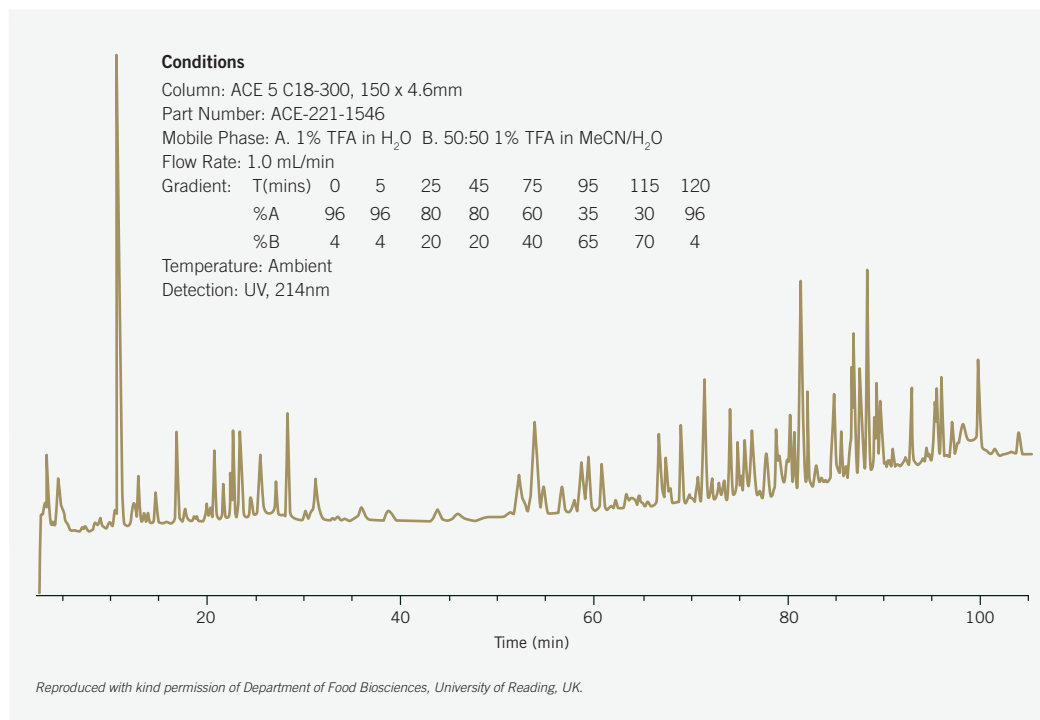

# C18-HL

## Mechanisms of Separation

Hydrophobic binding interactions

Shape selectivity

## Strength of Interaction

Very strong

Weak

## Target Analytes

Analytes differing in hydrophobicity

Polar, moderately polar, and non-polar analytes

Uncharged acids and bases

## Recommended Applications

Preparative

**FIGURE 20: Reproducible Scale-up with ACE C18-HL Columns**

### Conditions

Mobile Phase: 35:65 MeCN/0.1% TFA in H<sub>2</sub>O

Temperature: 22 °C

Wavelength: 254nm

### Compounds

1. Uracil
2. 4-Hydroxybenzoic acid
3. Acetylsalicylic acid
4. Benzoic acid
5. 2-Hydroxybenzoic acid
6. Ethyl paraben

### ACE 3 C18-HL

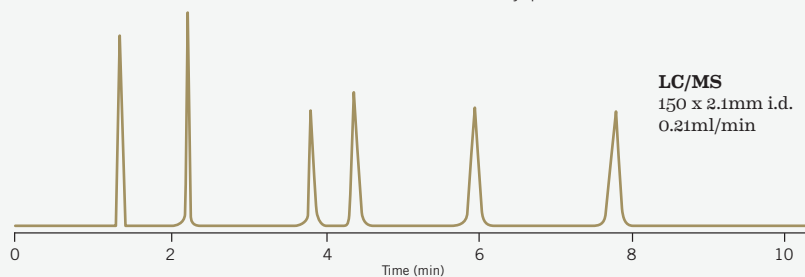

### ACE 5 C18-HL

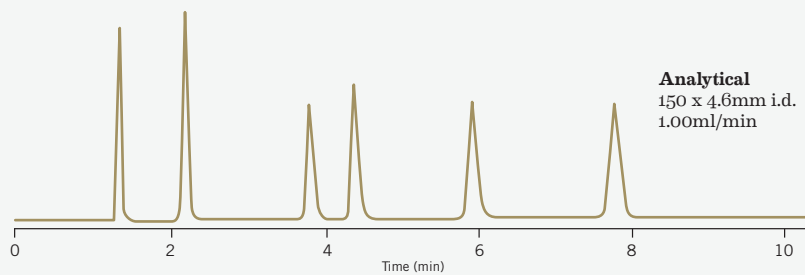

### ACE 10 C18-HL

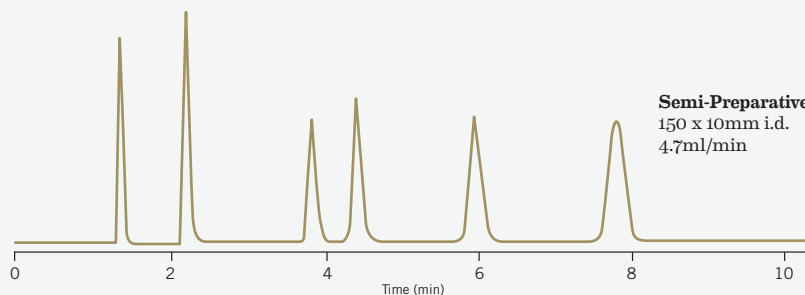

### ACE 15 C18-HL

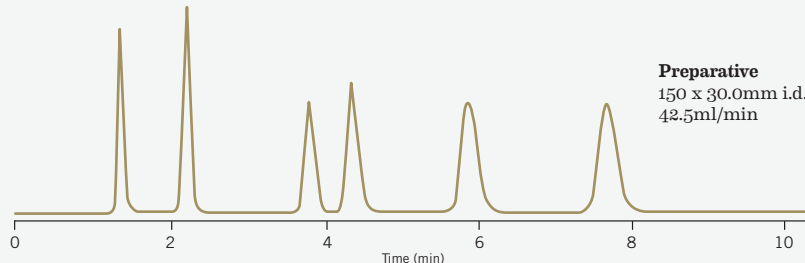

# C18-AR

(C18 with Phenyl group)

## Mechanisms of Separation

## Strength of Interaction

$\pi$ - $\pi$ interactions	Strong
Dipole-dipole interactions	Moderate
Hydrophobic binding interactions	Strong
Shape selectivity	Moderate

## Target Analytes

Analytes with  $\pi$  bonding

Analytes with electron delocalization and electron-withdrawing groups, such as halogens, nitro groups, ketones, esters, and acids

Analytes with different dipole moments

Analytes differing in hydrophobicity

Polar, moderately polar, and non-polar analytes

Uncharged acids and bases

## Recommended Applications

Analytes differing in hydrophobicity, homologous compounds differing by  $-\text{CH}_2$

Stereoisomers

Steroids

Taxanes

Substituted aromatics

Highly aqueous conditions

Particularly recommended for applications where a typical C18 does not provide an adequate separation

**FIGURE 21: Analgesics**

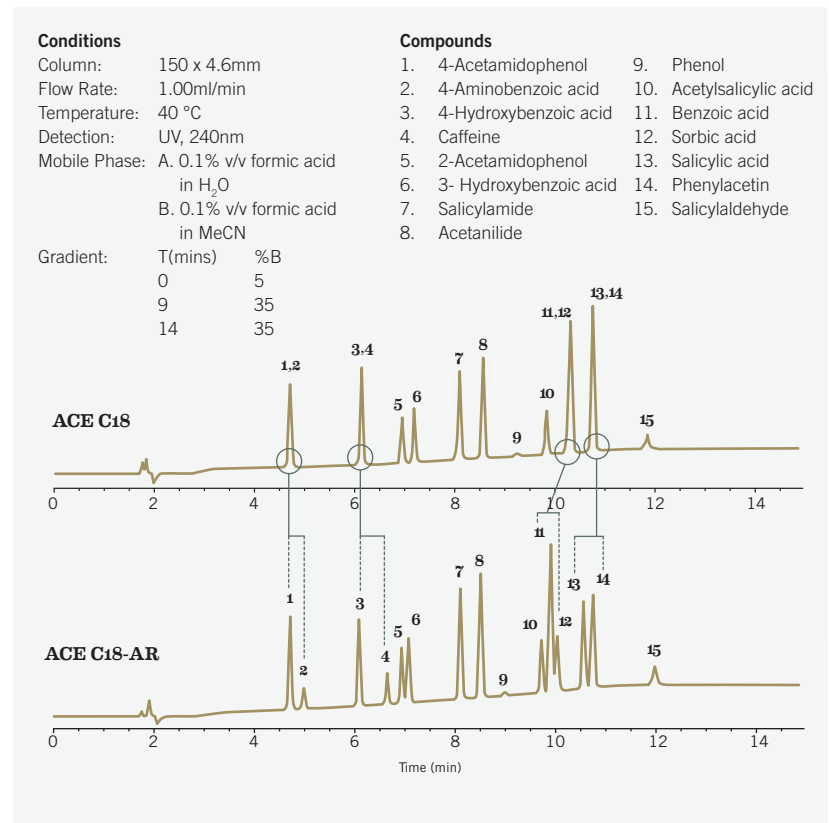

**FIGURE 22: Leveraging ACE Excel C18-AR Selectivity**

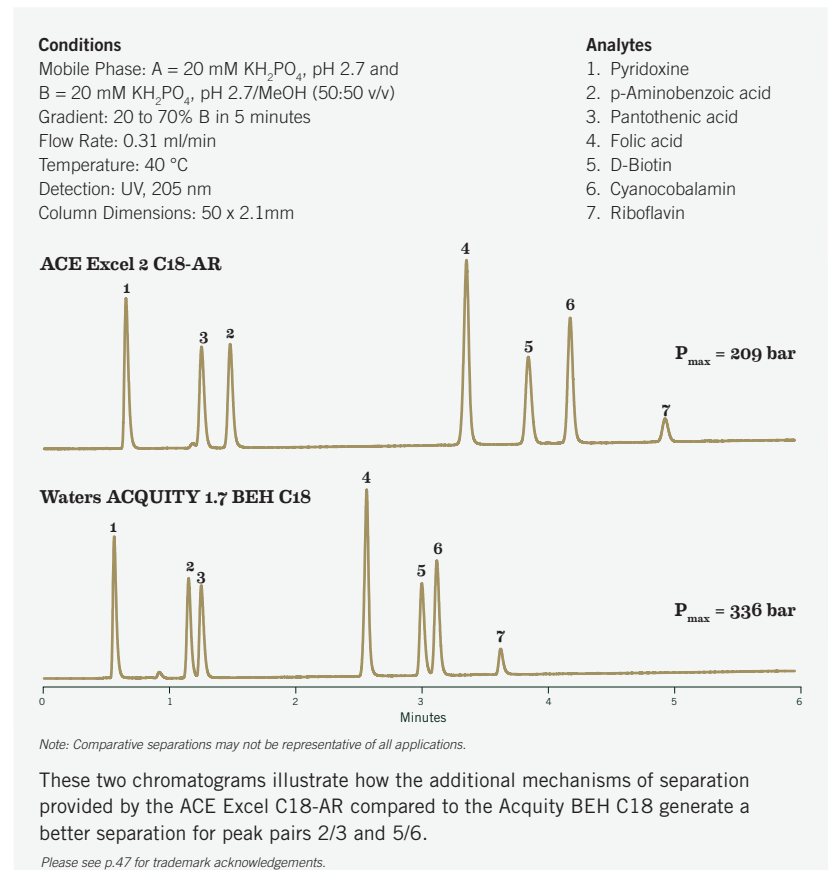

# C18-PFP

(C18 with pentafluorophenyl group)

Mechanisms of Separation	Strength of Interaction
$\pi$ - $\pi$ interactions	Strong
Dipole-dipole interactions	Strong
Hydrophobic binding interactions	Strong
Shape selectivity	Strong

## Target Analytes

Analytes with  $\pi$  bonding

Analytes with electron donating groups, such as phenols, aromatic ethers and amines

Analytes with proton donor groups

Analytes with different dipole moments

Analytes differing in hydrophobicity

Polar, moderately polar, and non-polar analytes

Uncharged acids and bases

## Recommended Applications

Stereoisomers

Steroids

Taxanes

Substituted aromatics

Analytes differing in hydrophobicity, homologous compounds differing by  $-\text{CH}_2$

Highly aqueous mobile phase conditions

Particularly recommended for applications where a typical C18 does not provide an adequate separation

**FIGURE 23: Leveraging the unique ACE Excel C18-PFP selectivity**

Conditions	Analytes
Mobile Phase: MeOH/H <sub>2</sub> O (50:50 v/v)	1. 1,2,3-Trimethoxybenzene
Flow Rate: 0.21 ml/min	2. 1,2-Dimethoxybenzene
Temperature: 40 °C	3. 1,2,4-Trimethoxybenzene
Column Dimensions: 50 x 2.1mm	4. Methoxybenzene
	5. 1,3-Dimethoxybenzene
	6. 1,3,5-Trimethoxybenzene
	7. Toluene

### ACE Excel 2 C18-PFP (fully porous ultra inert silica)

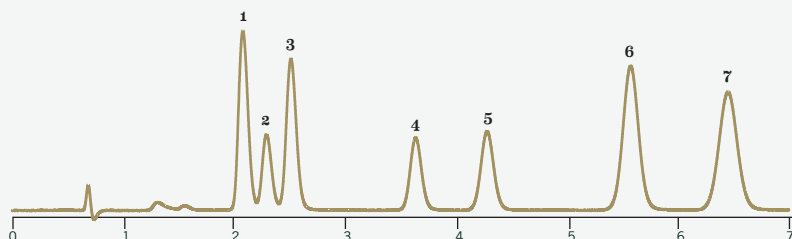

### Waters ACQUITY 1.7 BEH C18 (hybrid particle)

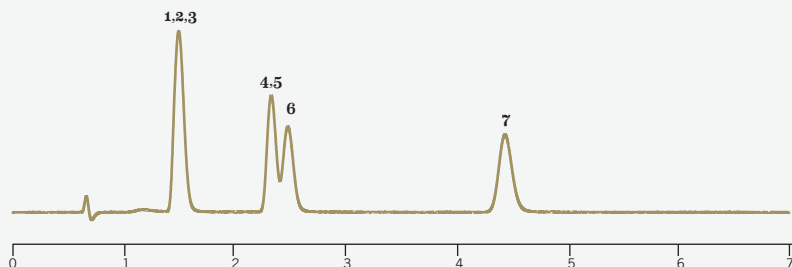

### Agilent Poroshell 2.7 120 EC C18 (superficially porous particle)

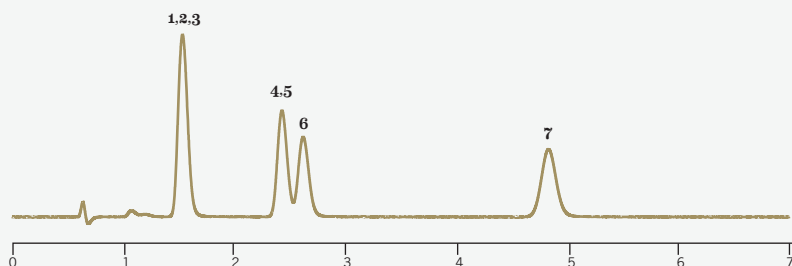

### Phenomenex Kinetex 2.6 C18 (core-shell particle)

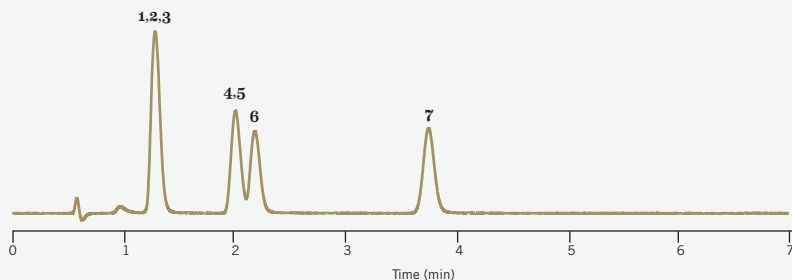

Note: Comparative separations may not be representative of all applications.

Other C18 UHPLC columns are unable to separate all 7 of these analytes under these conditions. In particular, hydrophobic binding interaction appears to offer no selectivity for separating peaks 1,2 and 3 and peaks 5 and 6. The ACE Excel C18-PFP, however, provides the selectivity needed to separate the co-eluting analytes. It is likely the additional selectivity provided by  $\pi$ - $\pi$  and dipole-dipole interactions is responsible for achieving the better overall separation.

Please see p.47 for trademark acknowledgements.

**FIGURE 24: ACE C18-PFP columns offer greater retention and differences in selectivity.**

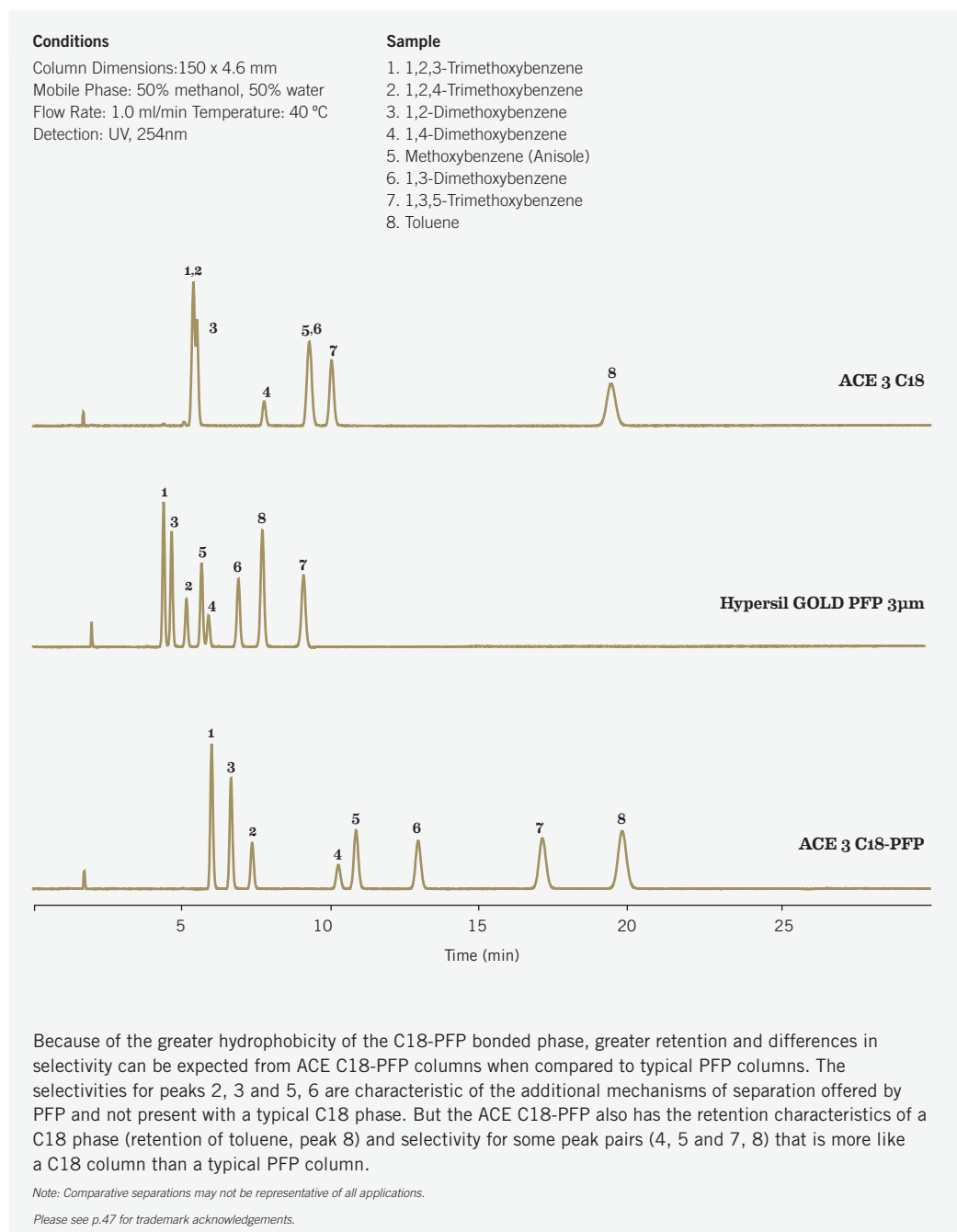

# C8

## Mechanisms of Separation

Hydrophobic binding interactions

## Strength of Interaction

Strong/Moderate

## Target Analytes

Analytes differing in hydrophobicity

Polar, moderately polar, and non-polar analytes

Uncharged acids and bases

Ionized acids or bases using ion-pairing

## Recommended Applications

Analytes differing in hydrophobicity,

Homologous compounds differing by  $-CH_2$

Mixtures containing polar and very hydrophobic analytes

Good starting phase for developing separation of proteins and large polypeptides. (300Å recommended)

# C4

## Mechanisms of Separation

Hydrophobic binding interactions

## Strength of Interaction

Moderate/Weak

## Target Analytes

Analytes differing in hydrophobicity

Polar, moderately polar, and non-polar analytes

Uncharged acids and bases

Ionized acids or bases using ion-pairing

## Recommended Applications

Analytes differing in hydrophobicity

Homologous compounds differing by  $-CH_2$

Larger molecules, such as polypeptides and proteins

**FIGURE 25: Vitamins–Water Soluble (Gradient)**

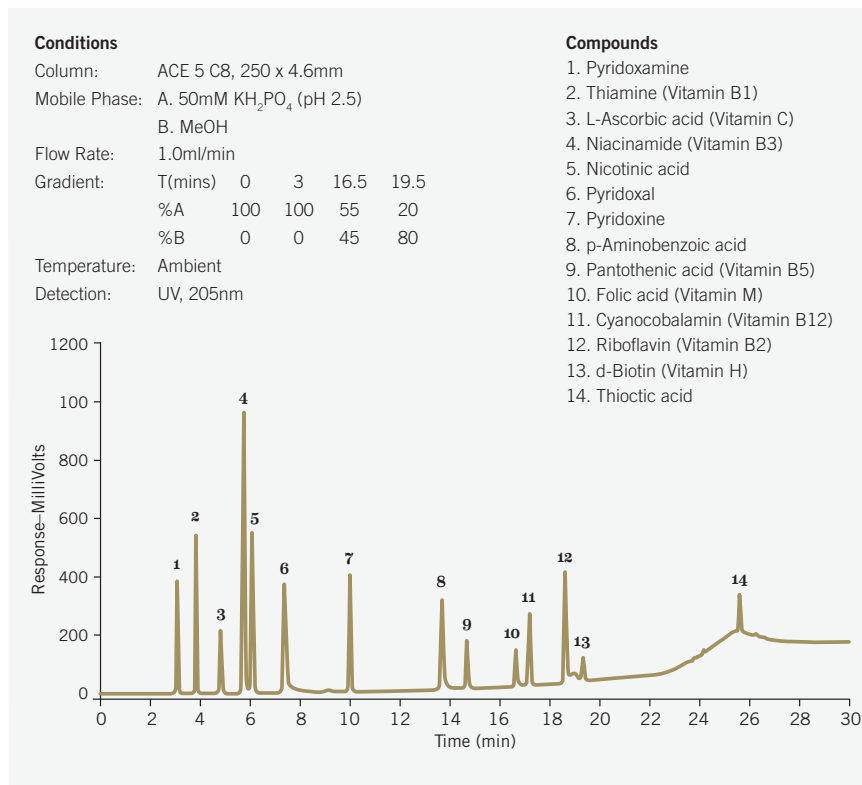

**FIGURE 26: Whey Proteins from Whole Milk**

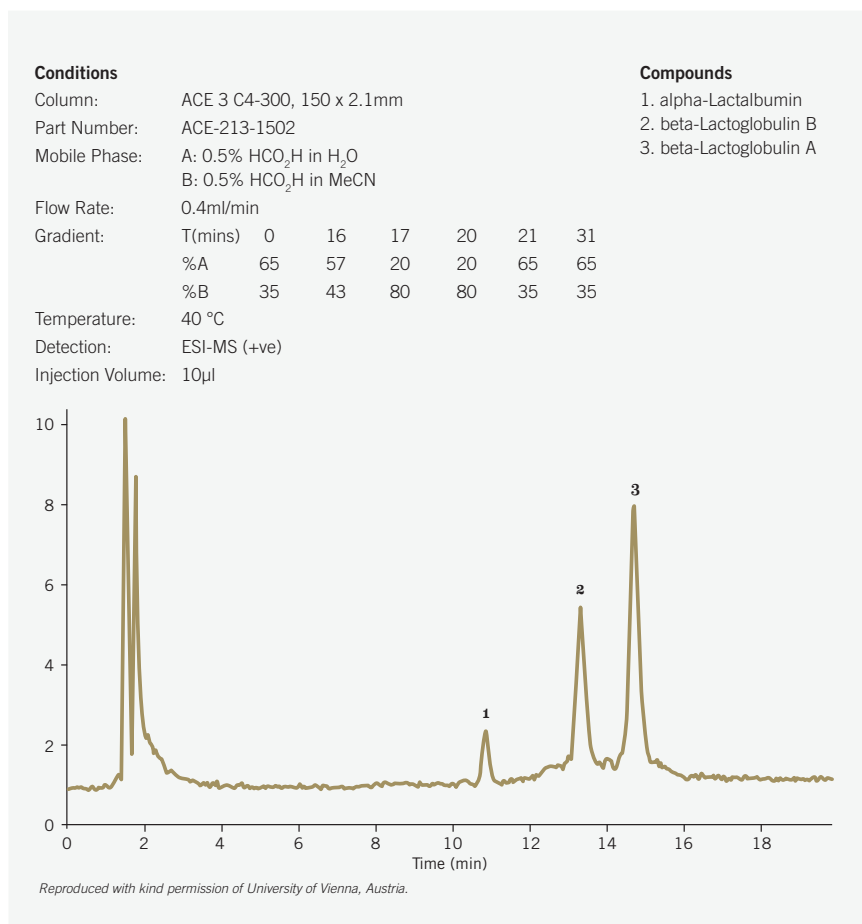



# Phenyl

## Mechanisms of Separation

Mechanisms of Separation	Strength of Interaction
$\pi$ - $\pi$ interactions	Strong
Dipole-dipole interactions	Moderate
Hydrophobic binding interactions	Moderate

## Target Analytes

Analytes with  $\pi$  bonding

Analytes with electron delocalization and electron-withdrawing groups, such as halogens, nitro groups, ketones, esters, and acids

Analytes with proton donor groups

Analytes with different dipole moments

## Recommended Applications

Stereoisomers

Steroids

Taxanes

Substituted aromatics

Highly aqueous conditions

# CN

## Mechanisms of Separation

Mechanisms of Separation	Strength of Interaction
Dipole-dipole interactions	Strong
Hydrophobic binding interactions	Weak

## Target Analytes

Polar analytes

Analytes with double and triple bonds

Non-polar analytes having too much retention on alkyl phases

## Recommended Applications

Mixtures of very polar and polar analytes

Antihistamines

Anaesthetics

As an orthogonal phase in RPLC method development

**FIGURE 27: Comparison of Selectivity differences between C18 and Phenyl phases**

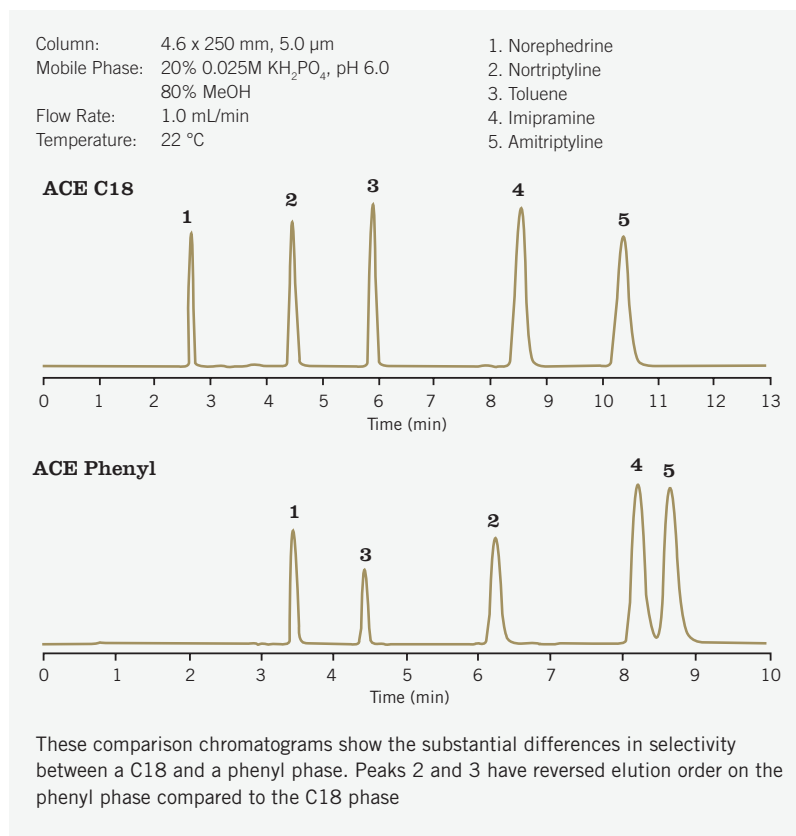

**FIGURE 28: Oxymetazoline in Nasal Spray Formulation**

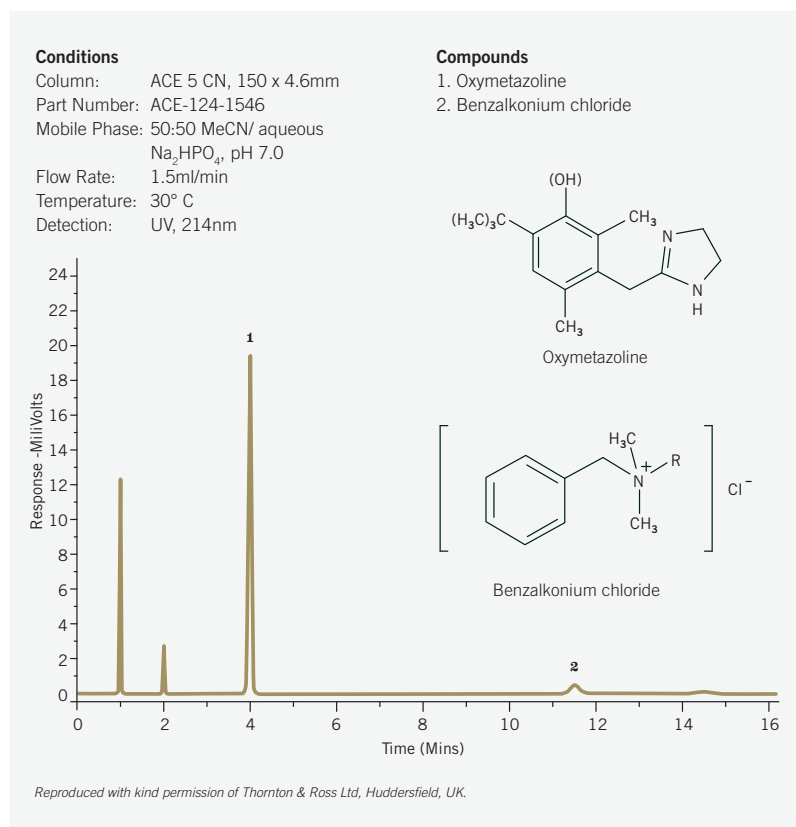

# AQ

## Mechanisms of Separation

Hydrophobic binding interactions

Dipole-dipole interactions

## Strength of Interaction

Moderate

Weak

## Target Analytes

Water soluble analytes

Very polar acids, bases and neutrals

## Recommended Applications

Isocratic separations with highly or 100% aqueous mobile phase

LC-MS, fast 0–100% gradients

Catecholamines, short chain organic acids, local anaesthetics

**FIGURE 29: Local Anaesthetics**

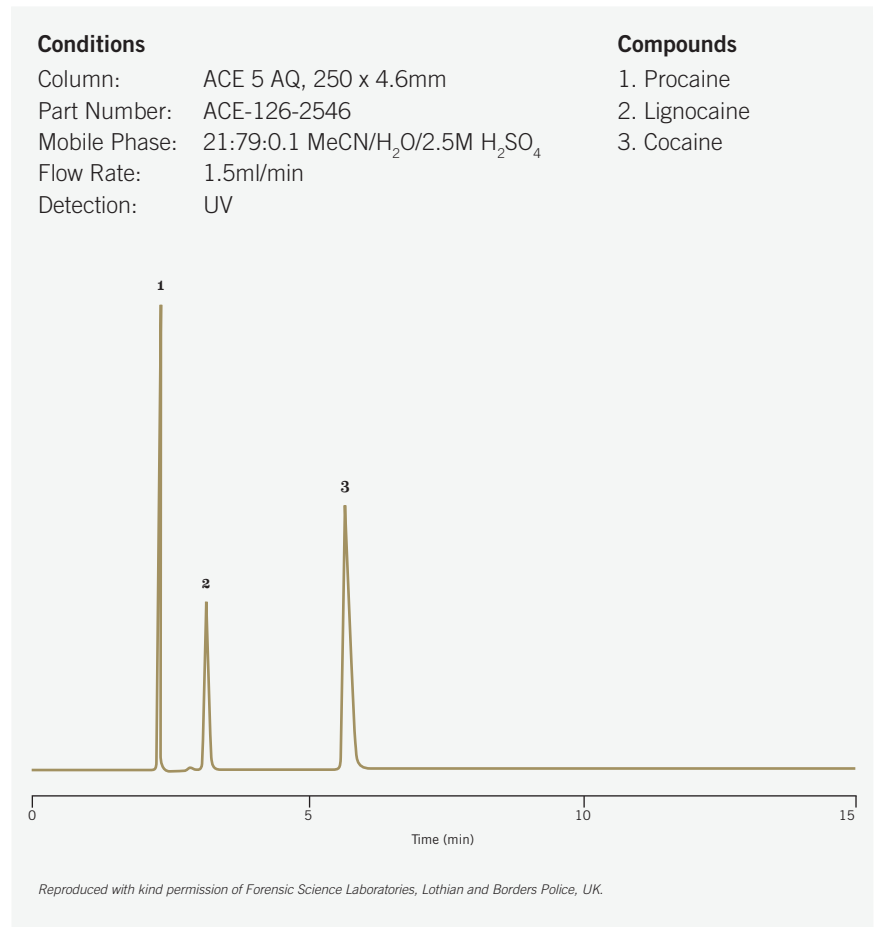

**FIGURE 30: Catecholamines**

**Conditions**

Column: ACE 5 AQ, 150 x 4.6mm  
Mobile Phase: (a) 50mM  $\text{KH}_2\text{PO}_4$ , (pH 3.0)  
(b) 50mM  $\text{KH}_2\text{PO}_4$ , (pH 2.0)  
(c) 0.1% TFA  
(d) 0.1%  $\text{HCO}_2\text{H}$   
Flow Rate: 1.0ml/min  
Temperature: Ambient  
Detection: UV, 210nm  
Injection Volume: 2 $\mu\text{l}$

**Compounds**

1. Noradrenaline
2. Adrenaline
3. L-DOPA
4. Dopamine
5. L-Tyrosine
6. VMA (vanillylmandelic acid)

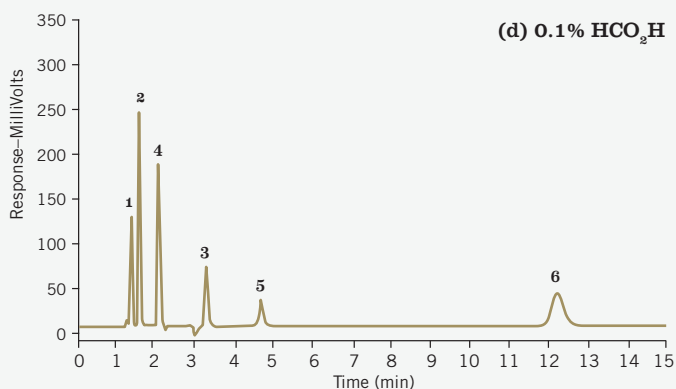
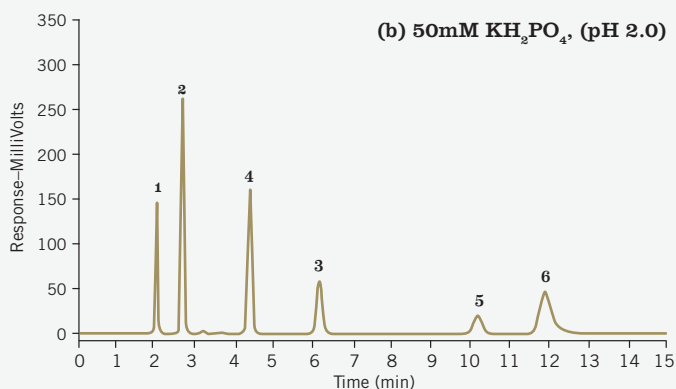
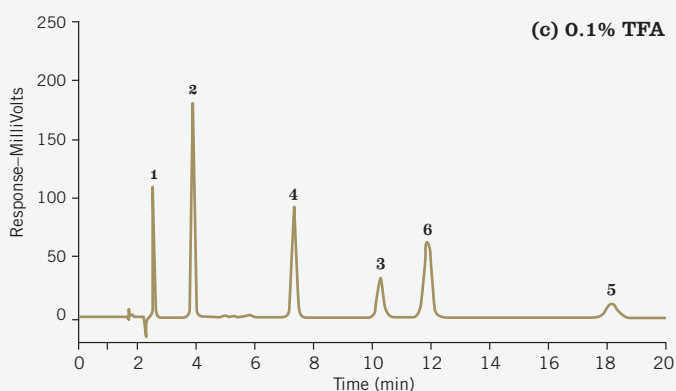
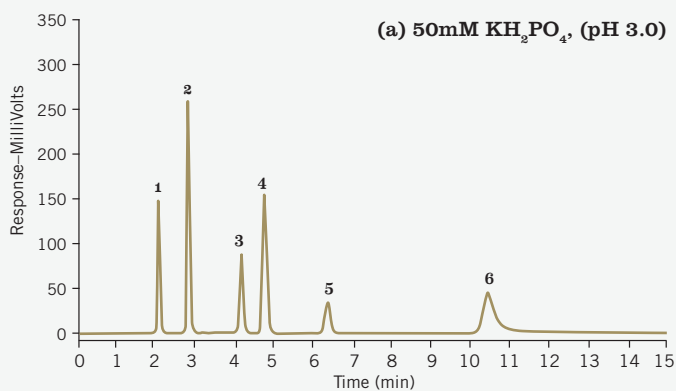

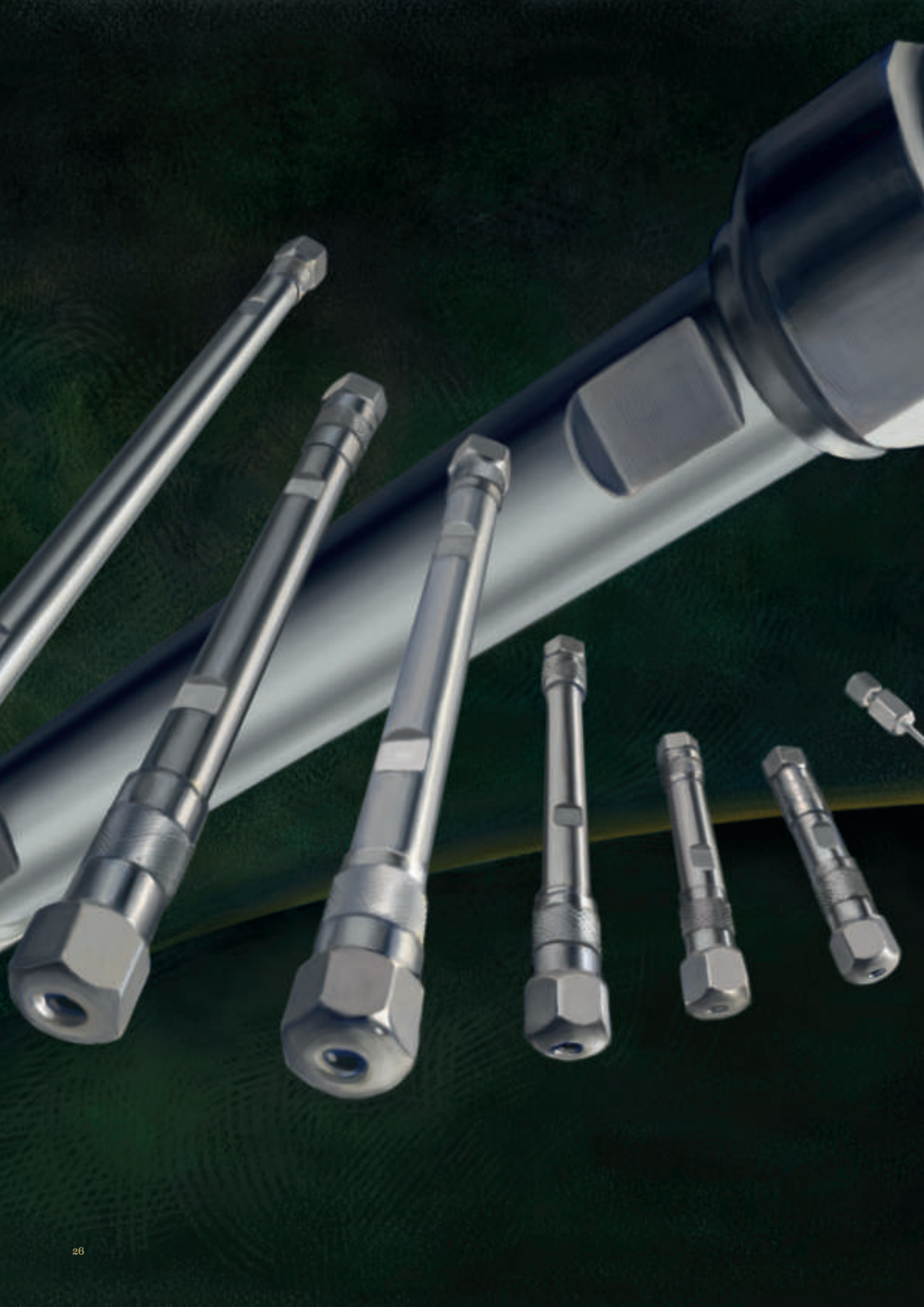



CHAPTER

# 3

The right column configurations for your HPLC & UHPLC needs.

**ACE Columns come in a variety of configurations: HPLC, UHPLC, Capillary, Nano, Preparative and Guard Columns.**

# ACE<sup>®</sup> Excel<sup>™</sup> UHPLC columns

## ACE Excel 2µm UHPLC columns

**Fully compatible with all commercial UPLC and UHPLC instruments**

**Brings renowned ACE HPLC columns' advantages to UHPLC columns**

**Provides users of UPLC/UHPLC with additional choices in stationary phases, including the powerful C18-AR and C18-PFP phases**

**Delivers a high level of reliability and ruggedness**

**Offers easy scalability from UHPLC to HPLC to preparative LC**

**Available in 2, 3 and 5µm particle sizes for UHPLC (see p45-46)**

Manufacturing UHPLC columns is tough and there is a general perception that they are not as rugged and reliable as HPLC Columns. By drawing on their vast experience in manufacturing the finest HPLC columns, Advanced Chromatography Technologies is able to produce very reliable UHPLC columns. Now, chromatographers will get even more from their UPLC and UHPLC instruments. Excellent peak shape for basic compounds, improved column-to-column reproducibility, additional stationary phases that leverage multiple mechanisms of separations, and improved column ruggedness are now available to UPLC and UHPLC users with ACE Excel UHPLC columns.

**FIGURE 31: ACE Excel delivers excellent resolution and peak shape**

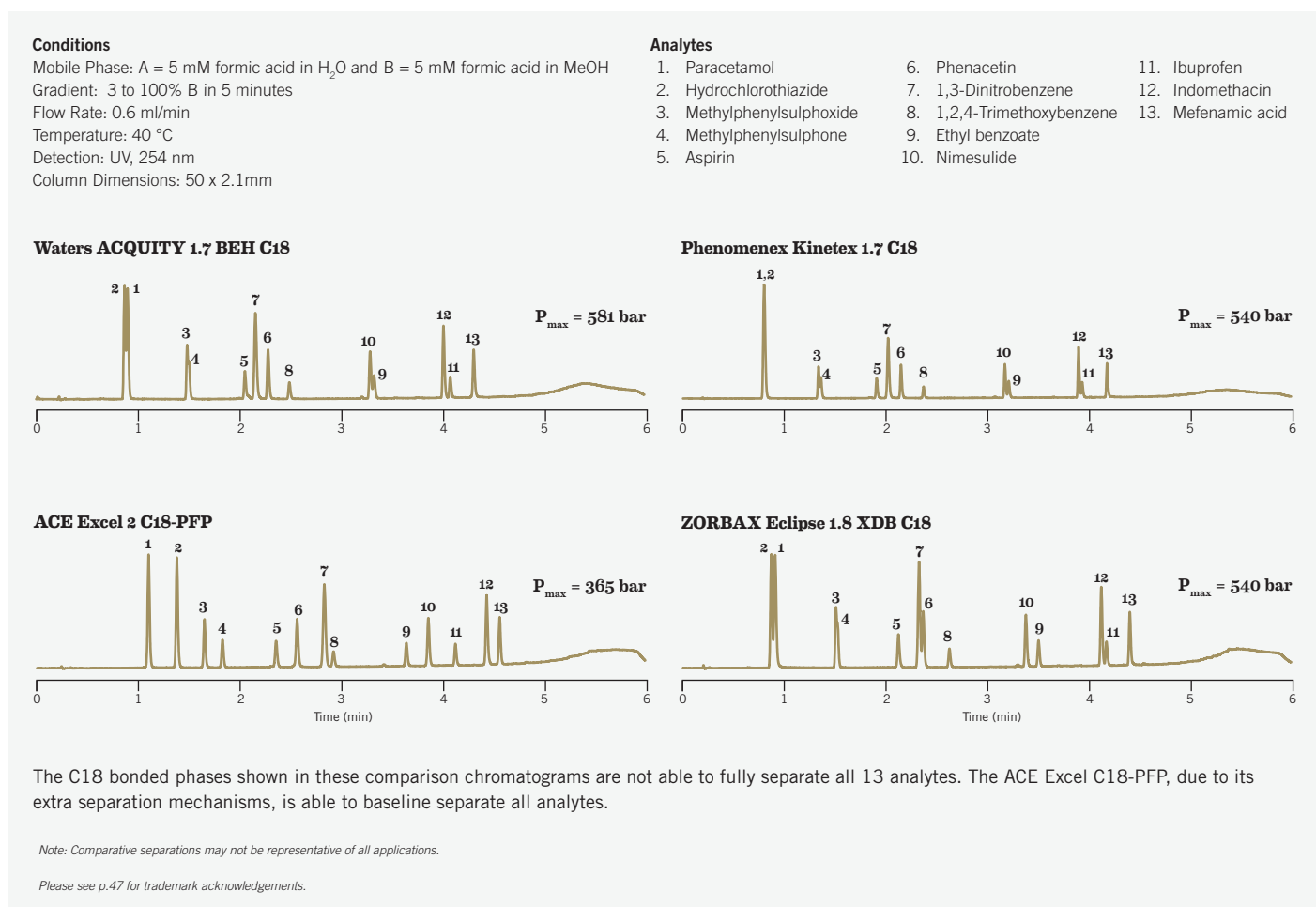

**FIGURE 32: ACE Excel UHPLC columns are compatible with all commercial UPLC and UHPLC instruments**

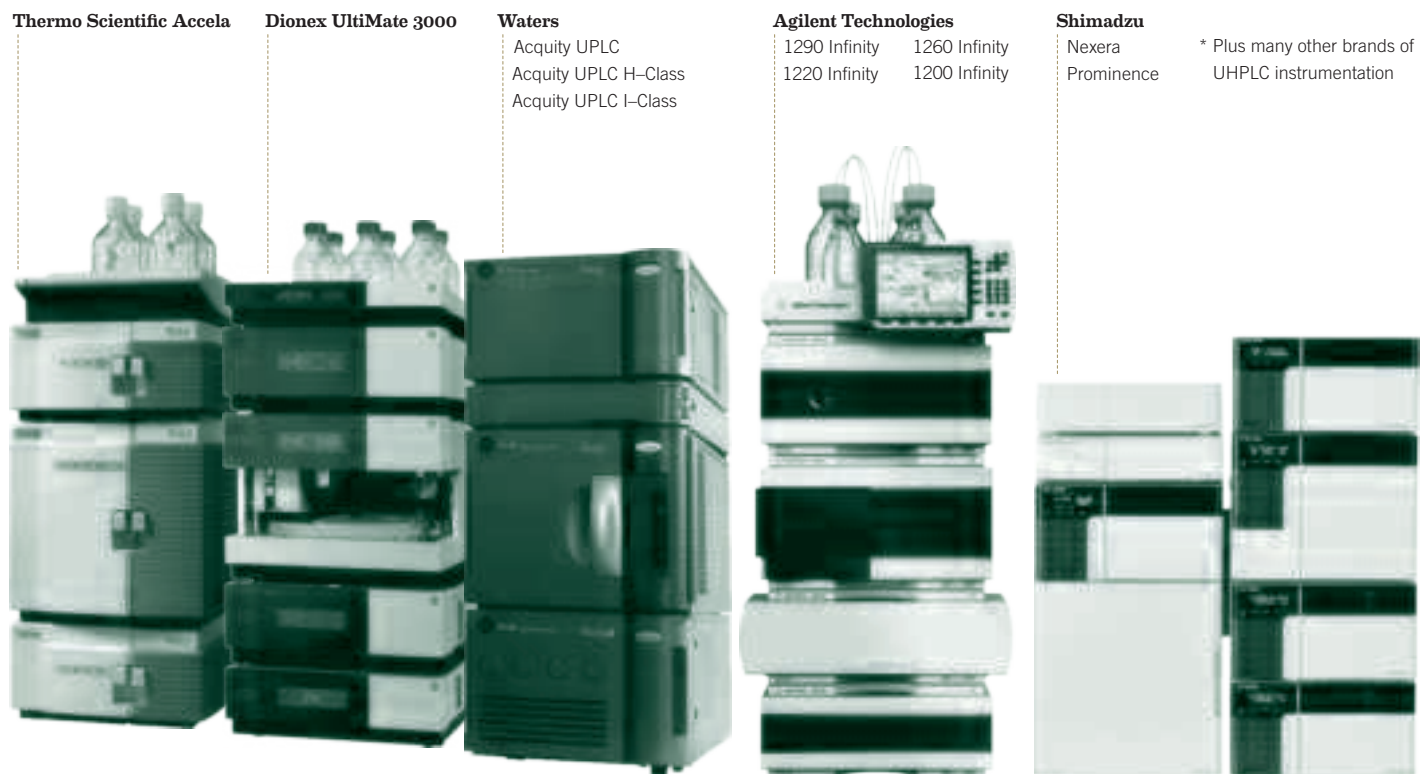

# ACE 300Å Columns for Peptides and Proteins

## ACE 300Å Columns for Peptides and Proteins

**300Å ultra high purity silica**

**C18, C8, C4, CN and Phenyl chemistries**

**3 µm, 5 µm and 10 µm particle sizes**

**Highly reproducible**

**Very stable**

Excellent peak shape and reproducibility have established ACE HPLC columns as the finest available. This quality is also available for protein chemists desiring the utmost in performance and reproducibility for the separation of peptides, proteins and other high molecular weight biomolecules. ACE 300Å columns are available in an extensive range of dimensions and particle sizes for use in micro-scale separations, LC/MS analyses and high speed preparative analyses up to process scale.

Chromatographers prefer inert stationary phases for the reversed-phase HPLC of ionizable compounds because they minimize the negative effect of silanols on the separation. This results in improved peak shape and reproducibility when separating compounds that contain polar functional groups, especially amines. A new generation of ultra-inert stationary phases, with extremely low silanol activity, has made it possible to achieve even better peak shape and reproducibility when separating these types of compounds. Scientists working with small molecules rapidly adopted this new technology and wide-pore (300Å) ultra-inert phases make the benefits of this technology available to those wanting to separate peptides and proteins by reversed-phase HPLC.

## The Benefits of Ultra-Inert Stationary Phases for the Reversed-Phase HPLC of Biomolecules

### INCREASED SENSITIVITY

TFA (trifluoroacetic acid) is used as a mobile phase additive for reversed-phase separations of peptides and proteins. This additive is typically used to improve both the peak shape and resolution of complex mixtures of peptides and proteins. As shown in Figure 34, the use of 0.1% TFA in the mobile phase enables a column packed with an active stationary phase to give peak widths comparable to those obtained from a new generation column made from ultra-inert stationary phase. However, as the TFA concentration is lowered to 0.01% and finally 0.005%, peak widths on the ultra-inert phase stay the same, but degrade on the active stationary phase. The ability to analyze peptides and proteins using very low levels of TFA is beneficial for high sensitivity detection by mass spectrometry. TFA complexes with polypeptides and can enhance selectivity. However, this same complexation lowers sensitivity in the mass spectrometer.

**FIGURE 33: ACE 300Å columns for Peptide and Protein Analyses**

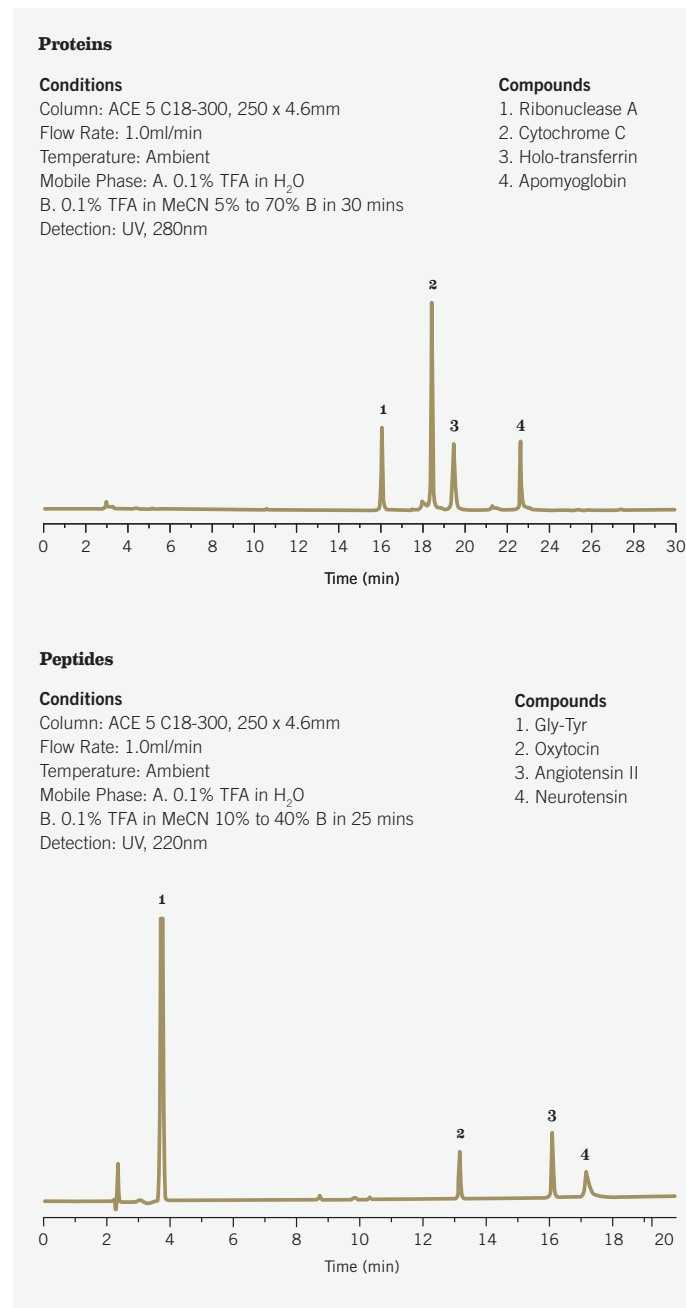



**FIGURE 34: Sensitivity and Peak Shape as a Function of TFA Concentration**

Column: 250 x 4.6 mm, 5µm C18 300Å  
 Mobile Phase: A: TFA in H<sub>2</sub>O  
 B: TFA in MeCN  
 (% TFA as specified above)  
 10% to 55% B in 37.5 mins.  
 Flow Rate: 1.5 mL/min  
 Detection: UV 200nm

**Compounds**  
 1. Gly-Tyr  
 2. Oxytocin  
 3. Angiotensin II  
 4. Neurotensin

**ACE 5 C18-300 Ultra-inert silica**

**0.1% TFA**

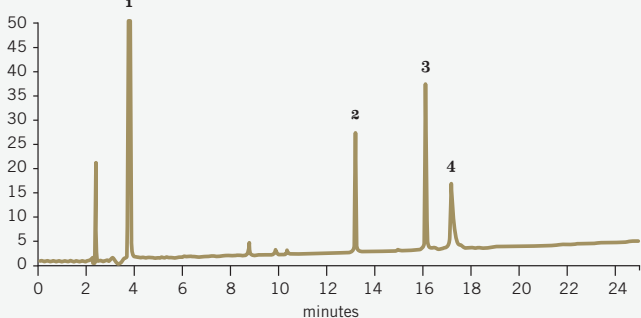

**Vydac 218TP Lower purity 'active' silica**

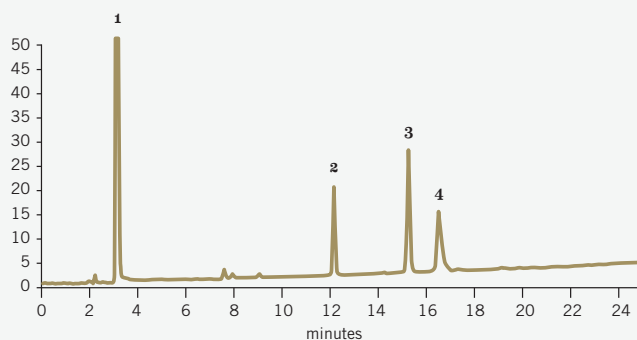

**0.01% TFA**

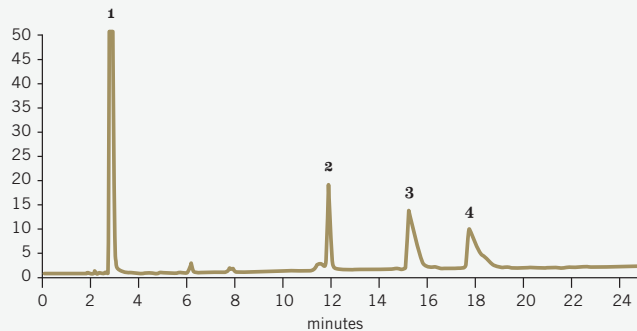
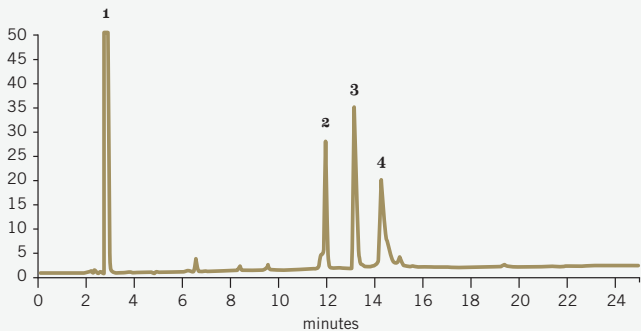

**0.005% TFA**

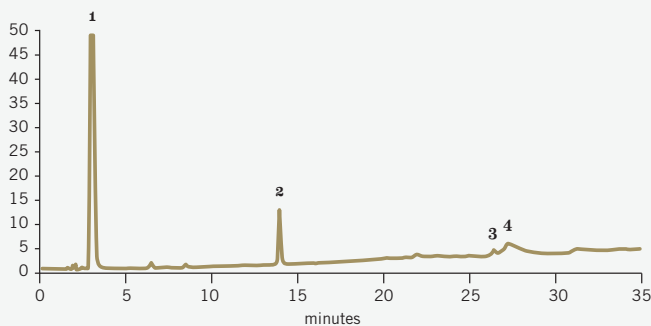
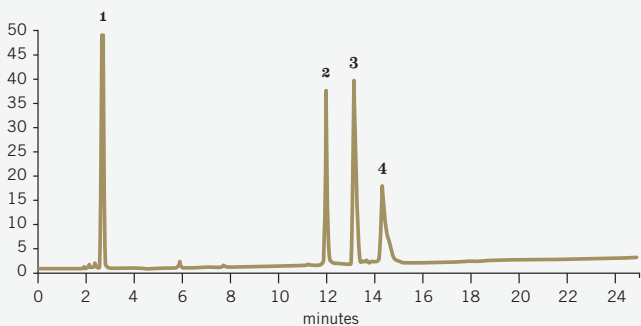

Columns based on less pure silica (chromatograms on right) show a dramatic loss in performance as TFA concentration is lowered. Columns made from ultra-inert silica such as ACE maintain performance when TFA concentration is decreased.

*Note: Comparative separations may not be representative of all applications.*

*Please see p.47 for trademark acknowledgements.*

## OPTIMIZING SELECTIVITY

The ability of TFA and other mobile phase additives to complex with peptides and proteins can be used to adjust selectivity and improve resolution. As shown in Figure 35, lowering TFA concentration from 0.1% to 0.01% enabled the resolution of angiotensin II and III. In

the case of the ultra-inert ACE column, peak shape and sensitivity remained constant with this change, as resolution improved dramatically. In the case of the Vydac column, packed with a more active stationary phase, peak shape was severely degraded.

**FIGURE 35: Selectivity as a Function of TFA Concentration**

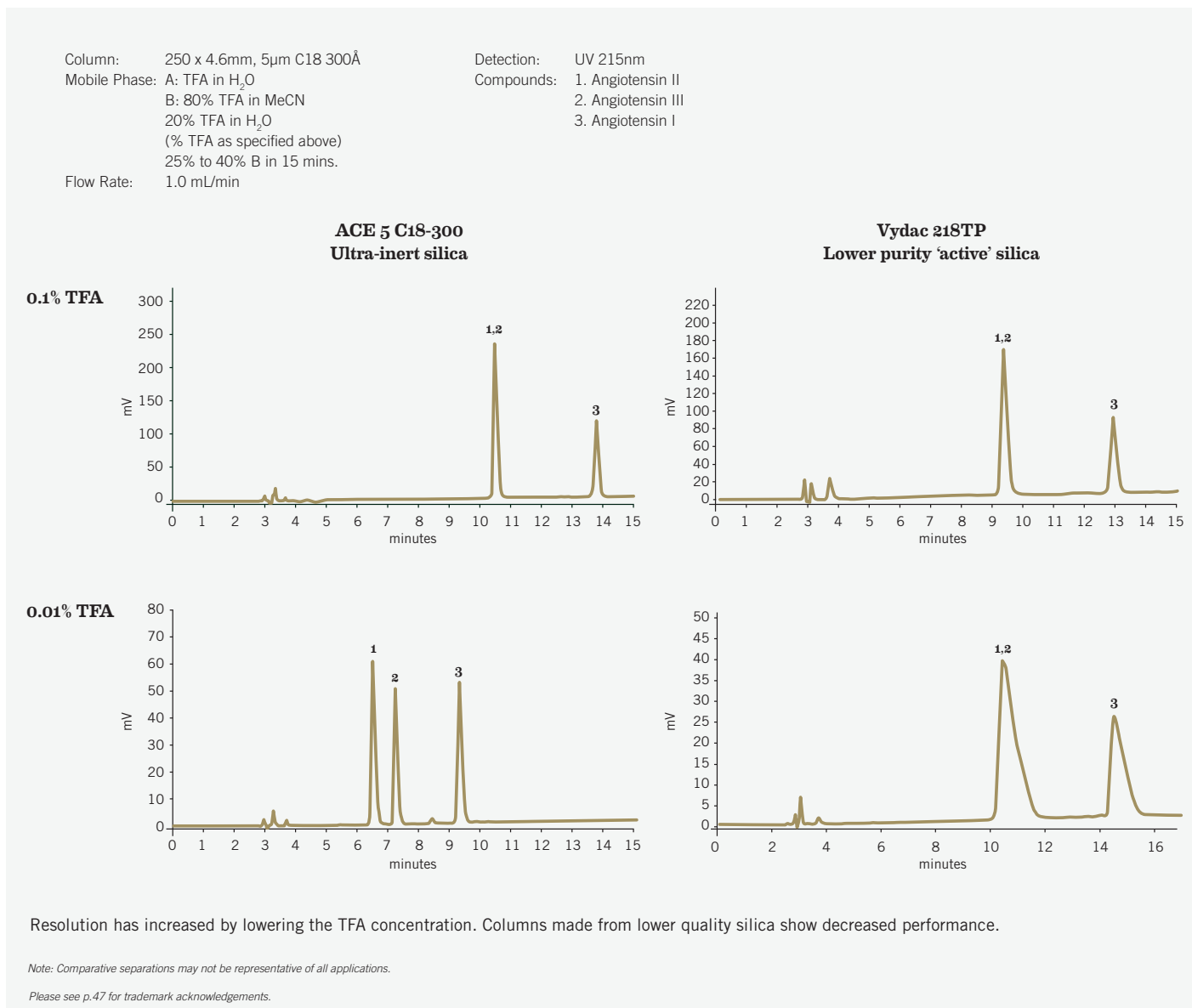

## INCREASED pH RANGE

Most biomolecules are charged. Peptides and proteins have numerous charges. From experience with small molecules, it is known that mobile phase pH can be a powerful tool for changing retention and thus optimizing the resolution of charged compounds. The same is true for peptides. Again using angiotensin II and III as an example, Figure 36 shows no resolution of these two peptides at pH 2 on either the ACE ultra-inert column or a column packed with a more active stationary phase. By increasing the pH to 7, both

columns now give good resolution. However, whereas the ACE ultra-inert column maintained good peak shape, the column packed with less pure silica showed poorer peak shape and a loss in performance. This phenomenon is observed in many reversed-phase applications with polar compounds. At mid pH, silanol interactions are more prevalent, and hence, peak tailing becomes more apparent on active stationary phases.

**FIGURE 36: Effect of Mobile Phase pH on Resolution**

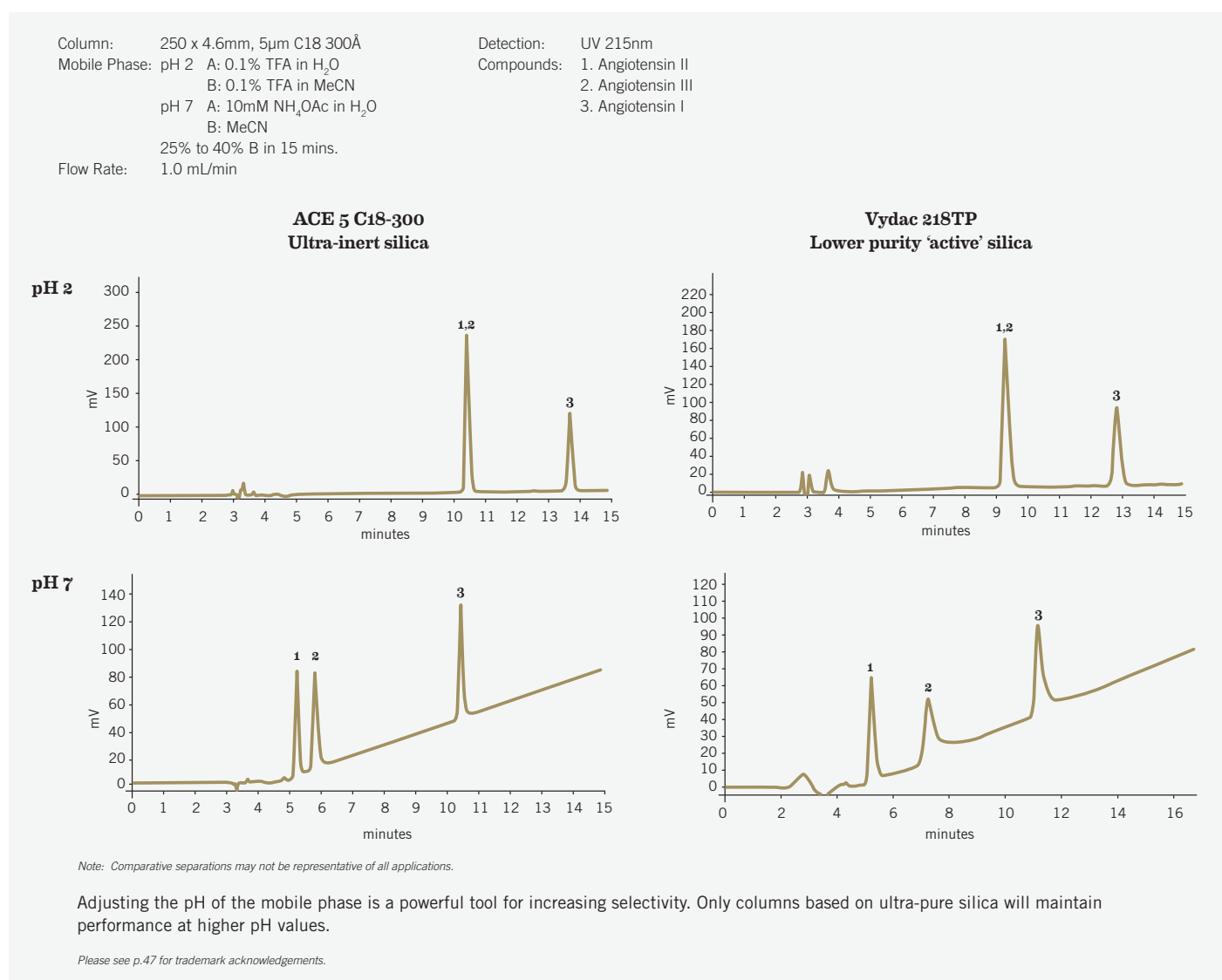

# ACE Capillary and Nano Columns



## ACE Capillary and Nano Columns

**Capillary (500 µm and 300 µm) and nano (100 µm and 75 µm) dimensions**

**Wide range of bonded phases available, including ACE C18-AR and ACE C18-PFP**

**100Å and 300Å pore sizes**

**High efficiency, long lifetime and guaranteed reproducibility**

**Particularly applicable for LC-MS and LC-MS-MS**

In addition to the extensive range of analytical (1.0-4.6 mm ID) through to preparative (21.2-30 mm ID) columns, ACE columns are available in capillary (500 µm and 300 µm) and nano (100 µm and 75 µm) dimensions. ACE capillary and nano columns are available with all ACE bonded phase chemistries in both 100Å and 300Å pore sizes. The same features that make ACE ultra-inert base deactivated columns the choice of method development chemists also make them the ideal choice for capillary and nano HPLC applications.

# ACE Preparative HPLC Columns



## ACE Preparative HPLC Columns

**Loadability:** high surface area and carbon load for maximum sample capacity

**Selectivity:** available in 9 bonded phases to optimize resolution and maximize sample capacity. C18, C18-AR, C18-PFP, C18-HL, C8, C4, CN, Phenyl, AQ

**Rugged:** reliable, long-term performance

**Guaranteed reproducibility:** complete column/batch validation just like the ACE analytical columns

## Now Achieve Reproducible High Performance Preparative Separations

Chromatographers with experience in preparative HPLC know what is important, resolution and loadability. The two go hand in hand; the greater the resolution, the higher the sample load, the faster you obtain pure compound. The ability to optimize resolution at the preparative scale means starting with high performance separations at the analytical scale. The same features that make ACE Ultra-Inert Base Deactivated analytical columns the choice of method development chemists also make them the ideal choice for scale-up and process methods.

## ACE Preparative Column features:

- Ultra high purity base deactivated silica
- 5, 10 and 15  $\mu\text{m}$  particle sizes available
- Columns are fully validated
- Exceptional reproducibility
- Excellent efficiencies
- Reliable, long-term performance
- 90 $\text{\AA}$ , 100 $\text{\AA}$  and 300 $\text{\AA}$  pore size

## Choose the Best Bonded Phase for Your Sample

ACE preparative columns are available in 9 bonded phase selectivities including C18-AR and C18-PFP, making it possible to optimize your preparative resolution and in doing so, increase loadability. ACE preparative columns are additionally available with unbonded silica for further options.

## Get High Purity Product Fast

ACE Preparative columns are available in a variety of column dimensions and particle sizes. For maximum loadability, choose 30 mm ID columns. Use a 50 mm length column with a 5  $\mu\text{m}$  particle size to maximize the speed of your separation. To maximize

**FIGURE 37: Reproducible Scale-up With ACE C18 Columns**

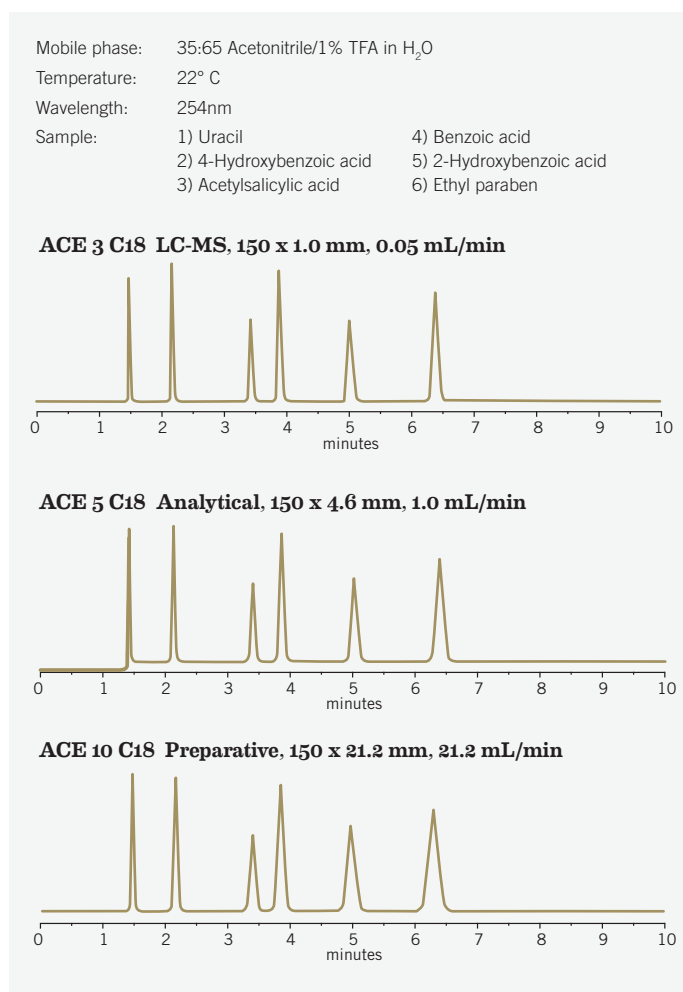

# ACE Guard Columns

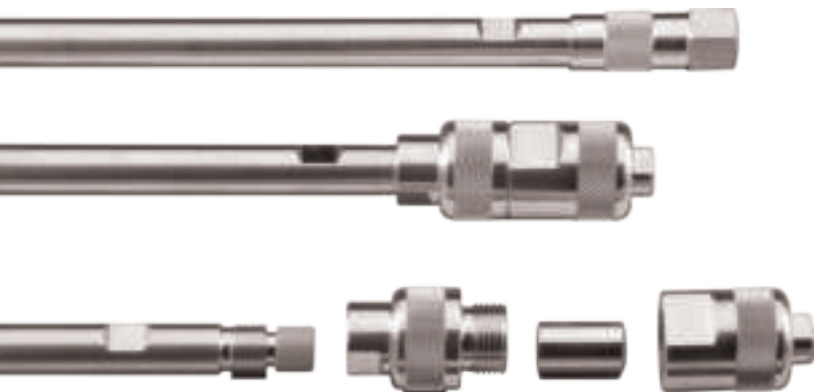

resolution, choose a 250 mm column with 5  $\mu\text{m}$  particle size.

ACE analytical columns are manufactured with state-of-the-art column fittings that incorporate the guard column as an integral part of the analytical column. To install a guard column on an ACE analytical column, simply replace the standard column inlet end-fitting with the end-fitting designed as a guard column holder. Then, insert a guard cartridge packed with the desired stationary phase into the guard column holder (See photograph). Don't worry about disturbing the packing bed when installing the guard column holder. It is well protected by a PEEK frit cap, even with the column end-fitting removed.

The integral guard column system is available for columns with internal diameters of 2.1, 3.0, and 4.6 mm. For preparative columns

## ACE Integral Guard Columns

**Guard column is incorporated into the analytical column's inlet end-fitting**

**Ultra low dead volume design provides protection without degrading performance**

**Easy to change cartridge design**

(> 10 mm), the more typical stand-alone style of guard columns are available packed with the appropriate stationary phase.

Stand-alone style guard column holders are also available for situations where they are preferred or required. A column coupler (p/n C0001), or connection tubing and fittings, will be required to use this style of guard column.

Using a guard column to protect your analytical column can substantially increase column lifetime and improve the quality of your chromatography. But, to be effective, the guard column must be replaced often enough to prevent contaminants from saturating the guard column and bleeding through to the analytical column. The best way to determine the optimum time to replace a guard column for a specific set of sample and mobile phase conditions is through experience. However, it is helpful to have some quantitative measure to help make the replacement decision. By monitoring plate number (N), pressure (P), and resolution ( $R_s$ ), the performance of the guard and analytical column can be closely watched to determine when a guard column should be replaced. We suggest replacing the guard column when any one of these parameters changes by more than 10%.

# Pre-Column Filters

Protect your HPLC and UHPLC columns from premature failure with Advanced Chromatography Technologies' quality pre-column filters.

One of the most common causes of HPLC column failure is particulate material collecting on the inlet frit of the column, causing high back pressure and/or distortion of peak shape. By one estimate,

over 70% of the failures of HPLC columns are caused by inlet frit plugging. UHPLC columns, especially those packed with sub-2 µm size particles, are particularly vulnerable to inlet frit plugging.

Advanced Chromatography Technologies offers three different pre-column filters, each designed for column specific protection.



## UltraShield™

### Pre-column filters for UHPLC and UPLC columns

As the name implies, UltraShield pre-column filters are engineered specifically for use in fast, high efficiency "UHPLC" separations requiring high mobile phase velocities and ultra-high pressure. The ultra-low dispersion of UltraShield maintains the efficiency of UHPLC columns, assuring no loss of critical resolution. With its simple design, UltraShield installs on any analytical, UHPLC or UPLC column in seconds and is leak tight to 1000 bar (15,000 psi). Simply finger tighten initially, then wrench tighten beyond finger tight an additional ¼ turn.

<b>Maximum Pressure</b>	<b>1000 bar</b>
<b>HPLC/UHPLC Column ID</b>	<b>1.0 to 4.6 mm</b>
<b>HPLC/UHPLC Column Length</b>	<b>30 to 250 mm</b>

ITEM DESCRIPTION	PART NO.
<b>UltraShield Pre-Column Filter</b> <i>0.5 µm porosity titanium filter element, 5/pkg</i>	<b>ACE-US1505</b>
<b>UltraShield Pre-Column Filter</b> <i>0.5 µm porosity titanium filter element, 10/pkg</i>	<b>ACE-US1510</b>

## ColumnShield™

### Pre-column filters for higher performance HPLC columns or smaller bore columns

3.5 µm and 3.0 µm particles are often packed in HPLC columns with smaller bores (<3.0 mm ID) and shorter lengths (20 - 50mm). These columns facilitate faster separations and are routinely employed with mass spectrometers as detectors. The operating pressure is not as high as with UHPLC columns, but the need still exists for low system dispersion, since these columns typically generate peaks with small volumes.

ColumnShield pre-column filters are optimal for these types of columns. They provide effective, low-dispersion filtering at a lower cost than the UltraShield. Although they are not recommended for ultra-high pressure applications, they can still be safely used at pressures up to 400 bar (6,000 psi). ColumnShield pre-column filters utilize a PEEK finger-tight design that connects directly to any ¼" 10-32 internal thread inlet fitting port, regardless of the manufacturer.

<b>Maximum Pressure</b>	<b>400 bar</b>
<b>HPLC/UHPLC Column ID</b>	<b>1.0 to 4.6 mm</b>
<b>HPLC/UHPLC Column Length</b>	<b>50 to 250 mm</b>

ITEM DESCRIPTION	PART NO.
<b>ColumnShield Pre-Column Filter</b> <i>0.5 µm porosity stainless steel filter element, 5/pkg</i>	<b>ACE-HP205</b>
<b>ColumnShield Pre-Column Filter</b> <i>0.5 µm porosity stainless steel filter element, 10/pkg</i>	<b>ACE-HP210</b>

## ColumnSaver™

### Pre-column filter for more typical standard bore (3.0 to 8.0 mm) HPLC columns

ColumnSavers provide economical protection for HPLC columns packed with 3 µm size particles or larger and with bore sizes (internal diameter) 3.0 mm to 8.0 mm. We even recommend using these pre-column filters on the inlet of guard columns to extend the life and reduce the replacement costs of these items.

<b>Maximum Pressure</b>	<b>300 bar</b>
<b>HPLC/UHPLC Column ID</b>	<b>3.0 to 8.0 mm</b>
<b>HPLC/UHPLC Column Length</b>	<b>50 to 300 mm</b>

ITEM DESCRIPTION	PART NO.
<b>ColumnSaver Pre-Column Filter</b> <i>with 0.5 µm porosity stainless steel filter element, 5/pkg</i>	<b>ACE-CS205</b>
<b>ColumnSaver Pre-Column Filter</b> <i>with 0.5 µm porosity stainless steel filter element, 10/pkg</i>	<b>ACE-CS210</b>

Please see p.47 for trademark acknowledgements.

**Part Numbers**

**ACE® 100Å Ultra-Inert Base Deactivated Analytical HPLC Columns**

For 2, 3 and 5µm ACE Excel UHPLC Columns please see pages 45-46

Dimension (mm)	Particle Size (µm)	ACE C18	ACE C18-AR	ACE C18-PFP	ACE C8	ACE C4
4.6 x 250	5	ACE-121-2546	ACE-129-2546	ACE-1210-2546	ACE-122-2546	ACE-123-2546
4.6 x 150	5	ACE-121-1546	ACE-129-1546	ACE-1210-1546	ACE-122-1546	ACE-123-1546
4.6 x 150	3	ACE-111-1546	ACE-119-1546	ACE-1110-1546	ACE-112-1546	ACE-113-1546
4.6 x 100	5	ACE-121-1046	ACE-129-1046	ACE-1210-1046	ACE-122-1046	ACE-123-1046
4.6 x 100	3	ACE-111-1046	ACE-119-1046	ACE-1110-1046	ACE-112-1046	ACE-113-1046
4.6 x 75	5	ACE-121-7546	ACE-129-7546	ACE-1210-7546	ACE-122-7546	ACE-123-7546
4.6 x 75	3	ACE-111-7546	ACE-119-7546	ACE-1110-7546	ACE-112-7546	ACE-113-7546
4.6 x 50	5	ACE-121-0546	ACE-129-0546	ACE-1210-0546	ACE-122-0546	ACE-123-0546
4.6 x 50	3	ACE-111-0546	ACE-119-0546	ACE-1110-0546	ACE-112-0546	ACE-113-0546
4.6 x 30	5	ACE-121-0346	ACE-129-0346	ACE-1210-0346	ACE-122-0346	ACE-123-0346
4.6 x 30	3	ACE-111-0346	ACE-119-0346	ACE-1110-0346	ACE-112-0346	ACE-113-0346
4.6 x 20	5	ACE-121-0246	ACE-129-0246	ACE-1210-0246	ACE-122-0246	ACE-123-0246
4.6 x 20	3	ACE-111-0246	ACE-119-0246	ACE-1110-0246	ACE-112-0246	ACE-113-0246
3.0 x 250	5	ACE-121-2503	ACE-129-2503	ACE-1210-2503	ACE-122-2503	ACE-123-2503
3.0 x 150	5	ACE-121-1503	ACE-129-1503	ACE-1210-1503	ACE-122-1503	ACE-123-1503
3.0 x 150	3	ACE-111-1503	ACE-119-1503	ACE-1110-1503	ACE-112-1503	ACE-113-1503
3.0 x 100	5	ACE-121-1003	ACE-129-1003	ACE-1210-1003	ACE-122-1003	ACE-123-1003
3.0 x 100	3	ACE-111-1003	ACE-119-1003	ACE-1110-1003	ACE-112-1003	ACE-113-1003
3.0 x 75	5	ACE-121-7503	ACE-129-7503	ACE-1210-7503	ACE-122-7503	ACE-123-7503
3.0 x 75	3	ACE-111-7503	ACE-119-7503	ACE-1110-7503	ACE-112-7503	ACE-113-7503
3.0 x 50	5	ACE-121-0503	ACE-129-0503	ACE-1210-0503	ACE-122-0503	ACE-123-0503
3.0 x 50	3	ACE-111-0503	ACE-119-0503	ACE-1110-0503	ACE-112-0503	ACE-113-0503
3.0 x 30	5	ACE-121-0303	ACE-129-0303	ACE-1210-0303	ACE-122-0303	ACE-123-0303
3.0 x 30	3	ACE-111-0303	ACE-119-0303	ACE-1110-0303	ACE-112-0303	ACE-113-0303
3.0 x 20	5	ACE-121-0203	ACE-129-0203	ACE-1210-0203	ACE-122-0203	ACE-123-0203
3.0 x 20	3	ACE-111-0203	ACE-119-0203	ACE-1110-0203	ACE-112-0203	ACE-113-0203
2.1 x 250	5	ACE-121-2502	ACE-129-2502	ACE-1210-2502	ACE-122-2502	ACE-123-2502
2.1 x 150	5	ACE-121-1502	ACE-129-1502	ACE-1210-1502	ACE-122-1502	ACE-123-1502
2.1 x 150	3	ACE-111-1502	ACE-119-1502	ACE-1110-1502	ACE-112-1502	ACE-113-1502
2.1 x 100	5	ACE-121-1002	ACE-129-1002	ACE-1210-1002	ACE-122-1002	ACE-123-1002
2.1 x 100	3	ACE-111-1002	ACE-119-1002	ACE-1110-1002	ACE-112-1002	ACE-113-1002
2.1 x 75	5	ACE-121-7502	ACE-129-7502	ACE-1210-7502	ACE-122-7502	ACE-123-7502
2.1 x 75	3	ACE-111-7502	ACE-119-7502	ACE-1110-7502	ACE-112-7502	ACE-113-7502
2.1 x 50	5	ACE-121-0502	ACE-129-0502	ACE-1210-0502	ACE-122-0502	ACE-123-0502
2.1 x 50	3	ACE-111-0502	ACE-119-0502	ACE-1110-0502	ACE-112-0502	ACE-113-0502
2.1 x 30	5	ACE-121-0302	ACE-129-0302	ACE-1210-0302	ACE-122-0302	ACE-123-0302
2.1 x 30	3	ACE-111-0302	ACE-119-0302	ACE-1110-0302	ACE-112-0302	ACE-113-0302
2.1 x 20	5	ACE-121-0202	ACE-129-0202	ACE-1210-0202	ACE-122-0202	ACE-123-0202
2.1 x 20	3	ACE-111-0202	ACE-119-0202	ACE-1110-0202	ACE-112-0202	ACE-113-0202
1.0 x 250	5	ACE-121-2501	ACE-129-2501	ACE-1210-2501	ACE-122-2501	ACE-123-2501
1.0 x 150	5	ACE-121-1501	ACE-129-1501	ACE-1210-1501	ACE-122-1501	ACE-123-1501
1.0 x 150	3	ACE-111-1501	ACE-119-1501	ACE-1110-1501	ACE-112-1501	ACE-113-1501
1.0 x 100	5	ACE-121-1001	ACE-129-1001	ACE-1210-1001	ACE-122-1001	ACE-123-1001
1.0 x 100	3	ACE-111-1001	ACE-119-1001	ACE-1110-1001	ACE-112-1001	ACE-113-1001
1.0 x 75	5	ACE-121-7501	ACE-129-7501	ACE-1210-7501	ACE-122-7501	ACE-123-7501
1.0 x 75	3	ACE-111-7501	ACE-119-7501	ACE-1110-7501	ACE-112-7501	ACE-113-7501
1.0 x 50	5	ACE-121-0501	ACE-129-0501	ACE-1210-0501	ACE-122-0501	ACE-123-0501
1.0 x 50	3	ACE-111-0501	ACE-119-0501	ACE-1110-0501	ACE-112-0501	ACE-113-0501

**ACE guard column cartridges for analytical columns 3.0 - 4.6 mm ID. Five guard cartridges per pack. Holder (H0005) required.**

Dimension (mm)	Particle Size (µm)	ACE C18	ACE C18-AR	ACE C18-PFP	ACE C8	ACE C4
For 3.0 - 4.6mm ID Columns	3	ACE-111-0103GD	ACE-119-0103GD	ACE-1110-0103GD	ACE-112-0103GD	ACE-113-0103GD
For 3.0 - 4.6mm ID Columns	5	ACE-121-0103GD	ACE-129-0103GD	ACE-1210-0103GD	ACE-122-0103GD	ACE-123-0103GD
Integral guard holder for above		H0005	H0005	H0005	H0005	H0005

The stand-alone guard cartridge holder should be used for all 20mm length columns.

**ACE guard column cartridges for narrow bore columns 2.1 mm ID. Five guard cartridges per pack. Holder (H0004) required.**

Dimension (mm)	Particle Size (µm)	ACE C18	ACE C18-AR	ACE C18-PFP	ACE C8	ACE C4
For 2.1mm ID Columns	3	ACE-111-0102GD	ACE-119-0102GD	ACE-1110-0102GD	ACE-112-0102GD	ACE-113-0102GD
For 2.1mm ID Columns	5	ACE-121-0102GD	ACE-129-0102GD	ACE-1210-0102GD	ACE-122-0102GD	ACE-123-0102GD
Integral guard holder for above		H0004	H0004	H0004	H0004	H0004

The stand-alone guard cartridge holder should be used for all 20mm length columns.

**ACE guard column cartridges for narrow bore columns 1.0 mm ID. Five guard cartridges per pack. Holder (H0001) and column coupler (C0001) required.**

Dimension (mm)	Particle Size (µm)	ACE C18	ACE C18-AR	ACE C18-PFP	ACE C8	ACE C4
For 1.0mm ID Columns	3	ACE-111-0101GD	ACE-119-0101GD	ACE-1110-0101GD	ACE-112-0101GD	ACE-113-0101GD
For 1.0mm ID Columns	5	ACE-121-0101GD	ACE-129-0101GD	ACE-1210-0101GD	ACE-122-0101GD	ACE-123-0101GD
Stand-alone guard holder for above		H0001	H0001	H0001	H0001	H0001

Note: A stand-alone guard cartridge holder is available for all the guard cartridges listed above. The part number for this guard cartridge holder is H0001. Connecting tubing and fittings, or a column coupler (part number C0001), is required to use this stand-alone guard cartridge holder.

Other dimensions are available. Please enquire for details.



**Part Numbers**

**ACE® 100Å Ultra-Inert Base Deactivated Analytical HPLC Columns (Continued)**

For 2, 3 and 5µm ACE Excel UHPLC Columns please see pages 45-46

Dimension (mm)	Particle Size (µm)	ACE CN	ACE Phenyl	ACE AQ	ACE SIL	ACE C18-HL
4.6 x 250	5	ACE-124-2546	ACE-125-2546	ACE-126-2546	ACE-127-2546	ACE-321-2546
4.6 x 150	5	ACE-124-1546	ACE-125-1546	ACE-126-1546	ACE-127-1546	ACE-321-1546
4.6 x 150	3	ACE-114-1546	ACE-115-1546	ACE-116-1546	ACE-117-1546	ACE-311-1546
4.6 x 100	5	ACE-124-1046	ACE-125-1046	ACE-126-1046	ACE-127-1046	ACE-321-1046
4.6 x 100	3	ACE-114-1046	ACE-115-1046	ACE-116-1046	ACE-117-1046	ACE-311-1046
4.6 x 75	5	ACE-124-7546	ACE-125-7546	ACE-126-7546	ACE-127-7546	ACE-321-7546
4.6 x 75	3	ACE-114-7546	ACE-115-7546	ACE-116-7546	ACE-117-7546	ACE-311-7546
4.6 x 50	5	ACE-124-0546	ACE-125-0546	ACE-126-0546	ACE-127-0546	ACE-321-0546
4.6 x 50	3	ACE-114-0546	ACE-115-0546	ACE-116-0546	ACE-117-0546	ACE-311-0546
4.6 x 30	5	ACE-124-0346	ACE-125-0346	ACE-126-0346	ACE-127-0346	ACE-321-0346
4.6 x 30	3	ACE-114-0346	ACE-115-0346	ACE-116-0346	ACE-117-0346	ACE-311-0346
4.6 x 20	5	ACE-124-0246	ACE-125-0246	ACE-126-0246	ACE-127-0246	ACE-321-0246
4.6 x 20	3	ACE-114-0246	ACE-115-0246	ACE-116-0246	ACE-117-0246	ACE-311-0246
3.0 x 250	5	ACE-124-2503	ACE-125-2503	ACE-126-2503	ACE-127-2503	ACE-311-2503
3.0 x 150	5	ACE-124-1503	ACE-125-1503	ACE-126-1503	ACE-127-1503	ACE-321-1503
3.0 x 150	3	ACE-114-1503	ACE-115-1503	ACE-116-1503	ACE-117-1503	ACE-311-1503
3.0 x 100	5	ACE-124-1003	ACE-125-1003	ACE-126-1003	ACE-127-1003	ACE-321-1003
3.0 x 100	3	ACE-114-1003	ACE-115-1003	ACE-116-1003	ACE-117-1003	ACE-311-1003
3.0 x 75	5	ACE-124-7503	ACE-125-7503	ACE-126-7503	ACE-127-7503	ACE-321-7503
3.0 x 75	3	ACE-114-7503	ACE-115-7503	ACE-116-7503	ACE-117-7503	ACE-311-7503
3.0 x 50	5	ACE-124-0503	ACE-125-0503	ACE-126-0503	ACE-127-0503	ACE-321-0503
3.0 x 50	3	ACE-114-0503	ACE-115-0503	ACE-116-0503	ACE-117-0503	ACE-311-0503
3.0 x 30	5	ACE-124-0303	ACE-125-0303	ACE-126-0303	ACE-127-0303	ACE-321-0303
3.0 x 30	3	ACE-114-0303	ACE-115-0303	ACE-116-0303	ACE-117-0303	ACE-311-0303
3.0 x 20	5	ACE-124-0203	ACE-125-0203	ACE-126-0203	ACE-127-0203	ACE-321-0203
3.0 x 20	3	ACE-114-0203	ACE-115-0203	ACE-116-0203	ACE-117-0203	ACE-311-0203
2.1 x 250	5	ACE-124-2502	ACE-125-2502	ACE-126-2502	ACE-127-2502	ACE-321-2502
2.1 x 150	5	ACE-124-1502	ACE-125-1502	ACE-126-1502	ACE-127-1502	ACE-321-1502
2.1 x 150	3	ACE-114-1502	ACE-115-1502	ACE-116-1502	ACE-117-1502	ACE-311-1502
2.1 x 100	5	ACE-124-1002	ACE-125-1002	ACE-126-1002	ACE-127-1002	ACE-321-1002
2.1 x 100	3	ACE-114-1002	ACE-115-1002	ACE-116-1002	ACE-117-1002	ACE-311-1002
2.1 x 75	5	ACE-124-7502	ACE-125-7502	ACE-126-7502	ACE-127-7502	ACE-321-7502
2.1 x 75	3	ACE-114-7502	ACE-115-7502	ACE-116-7502	ACE-117-7502	ACE-311-7502
2.1 x 50	5	ACE-124-0502	ACE-125-0502	ACE-126-0502	ACE-127-0502	ACE-321-0502
2.1 x 50	3	ACE-114-0502	ACE-115-0502	ACE-116-0502	ACE-117-0502	ACE-311-0502
2.1 x 30	5	ACE-124-0302	ACE-125-0302	ACE-126-0302	ACE-127-0302	ACE-321-0302
2.1 x 30	3	ACE-114-0302	ACE-115-0302	ACE-116-0302	ACE-117-0302	ACE-311-0302
2.1 x 20	5	ACE-124-0202	ACE-125-0202	ACE-126-0202	ACE-127-0202	ACE-321-0202
2.1 x 20	3	ACE-114-0202	ACE-115-0202	ACE-116-0202	ACE-117-0202	ACE-311-0202
1.0 x 250	5	ACE-124-2501	ACE-125-2501	ACE-126-2501	ACE-127-2501	ACE-321-2501
1.0 x 150	5	ACE-124-1501	ACE-125-1501	ACE-126-1501	ACE-127-1501	ACE-321-1501
1.0 x 150	3	ACE-114-1501	ACE-115-1501	ACE-116-1501	ACE-117-1501	ACE-311-1501
1.0 x 100	5	ACE-124-1001	ACE-125-1001	ACE-126-1001	ACE-127-1001	ACE-321-1001
1.0 x 100	3	ACE-114-1001	ACE-115-1001	ACE-116-1001	ACE-117-1001	ACE-311-1001
1.0 x 75	5	ACE-124-7501	ACE-125-7501	ACE-126-7501	ACE-127-7501	ACE-321-7501
1.0 x 75	3	ACE-114-7501	ACE-115-7501	ACE-116-7501	ACE-117-7501	ACE-311-7501
1.0 x 50	5	ACE-124-0501	ACE-125-0501	ACE-126-0501	ACE-127-0501	ACE-321-0501
1.0 x 50	3	ACE-114-0501	ACE-115-0501	ACE-116-0501	ACE-117-0501	ACE-311-0501

**ACE guard column cartridges for analytical columns 3.0 - 4.6 mm ID. Five guard cartridges per pack. Holder (H0005) required.**

Dimension (mm)	Particle Size (µm)	ACE CN	ACE Phenyl	ACE AQ	ACE SIL	ACE C18-HL
For 3.0 - 4.6mm ID Columns	3	ACE-114-0103GD	ACE-115-0103GD	ACE-116-0103GD	ACE-117-0103GD	ACE-311-0103GD
For 3.0 - 4.6mm ID Columns	5	ACE-124-0103GD	ACE-125-0103GD	ACE-126-0103GD	ACE-127-0103GD	ACE-321-0103GD
Integral guard holder for above		H0005	H0005	H0005	H0005	H0005

The stand-alone guard cartridge holder should be used for all 20mm length columns.

**ACE guard column cartridges for narrow bore columns 2.1 mm ID. Five guard cartridges per pack. Holder (H0004) required.**

Dimension (mm)	Particle Size (µm)	ACE CN	ACE Phenyl	ACE AQ	ACE SIL	ACE C18-HL
For 2.1mm ID Columns	3	ACE-114-0102GD	ACE-115-0102GD	ACE-116-0102GD	ACE-117-0102GD	ACE-311-0102GD
For 2.1mm ID Columns	5	ACE-124-0102GD	ACE-125-0102GD	ACE-126-0102GD	ACE-127-0102GD	ACE-321-0102GD
Integral guard holder for above		H0004	H0004	H0004	H0004	H0004

The stand-alone guard cartridge holder should be used for all 20mm length columns.

**ACE guard column cartridges for narrow bore columns 1.0 mm ID. Five guard cartridges per pack. Holder (H0001) and column coupler (C0001) required.**

Dimension (mm)	Particle Size (µm)	ACE CN	ACE Phenyl	ACE AQ	ACE SIL	ACE C18-HL
For 1.0mm ID Columns	3	ACE-114-0101GD	ACE-115-0101GD	ACE-116-0101GD	ACE-117-0101GD	ACE-311-0101GD
For 1.0mm ID Columns	5	ACE-124-0101GD	ACE-125-0101GD	ACE-126-0101GD	ACE-127-0101GD	ACE-321-0101GD
Stand-alone guard holder for above		H0001	H0001	H0001	H0001	H0001

Note: A stand-alone guard cartridge holder is available for all the guard cartridges listed above. The part number for this guard cartridge holder is H0001. Connecting tubing and fittings, or a column coupler (part number C0001), is required to use this stand-alone guard cartridge holder.

Other dimensions are available. Please enquire for details.

**Part Numbers**

**ACE® 300Å Ultra-Inert Base Deactivated Analytical HPLC Columns for Peptides/Proteins**

Dimension (mm)	Particle Size (µm)	ACE C18-300	ACE C8-300	ACE C4-300	ACE CN-300	ACE Phenyl-300
4.6 x 250	5	ACE-221-2546	ACE-222-2546	ACE-223-2546	ACE-224-2546	ACE-225-2546
4.6 x 150	5	ACE-221-1546	ACE-222-1546	ACE-223-1546	ACE-224-1546	ACE-225-1546
4.6 x 150	3	ACE-211-1546	ACE-212-1546	ACE-213-1546	ACE-214-1546	ACE-215-1546
4.6 x 100	5	ACE-221-1046	ACE-222-1046	ACE-223-1046	ACE-224-1046	ACE-225-1046
4.6 x 100	3	ACE-211-1046	ACE-212-1046	ACE-213-1046	ACE-214-1046	ACE-215-1046
4.6 x 75	5	ACE-221-7546	ACE-222-7546	ACE-223-7546	ACE-224-7546	ACE-225-7546
4.6 x 75	3	ACE-211-7546	ACE-212-7546	ACE-213-7546	ACE-214-7546	ACE-215-7546
4.6 x 50	5	ACE-221-0546	ACE-222-0546	ACE-223-0546	ACE-224-0546	ACE-225-0546
4.6 x 50	3	ACE-211-0546	ACE-212-0546	ACE-213-0546	ACE-214-0546	ACE-215-0546
4.6 x 30	5	ACE-221-0346	ACE-222-0346	ACE-223-0346	ACE-224-0346	ACE-225-0346
4.6 x 30	3	ACE-211-0346	ACE-212-0346	ACE-213-0346	ACE-214-0346	ACE-215-0346
4.6 x 20	5	ACE-221-0246	ACE-222-0246	ACE-223-0246	ACE-224-0246	ACE-225-0246
4.6 x 20	3	ACE-211-0246	ACE-212-0246	ACE-213-0246	ACE-214-0246	ACE-215-0246
3.0 x 250	5	ACE-221-2503	ACE-222-2503	ACE-223-2503	ACE-224-2503	ACE-225-2503
3.0 x 150	5	ACE-221-1503	ACE-222-1503	ACE-223-1503	ACE-224-1503	ACE-225-1503
3.0 x 150	3	ACE-211-1503	ACE-212-1503	ACE-213-1503	ACE-214-1503	ACE-215-1503
3.0 x 100	5	ACE-221-1003	ACE-222-1003	ACE-223-1003	ACE-224-1003	ACE-225-1003
3.0 x 100	3	ACE-211-1003	ACE-212-1003	ACE-213-1003	ACE-214-1003	ACE-215-1003
3.0 x 75	5	ACE-221-7503	ACE-222-7503	ACE-223-7503	ACE-224-7503	ACE-225-7503
3.0 x 75	3	ACE-211-7503	ACE-212-7503	ACE-213-7503	ACE-214-7503	ACE-215-7503
3.0 x 50	5	ACE-221-0503	ACE-222-0503	ACE-223-0503	ACE-224-0503	ACE-225-0503
3.0 x 50	3	ACE-211-0503	ACE-212-0503	ACE-213-0503	ACE-214-0503	ACE-215-0503
3.0 x 30	5	ACE-221-0303	ACE-222-0303	ACE-223-0303	ACE-224-0303	ACE-225-0303
3.0 x 30	3	ACE-211-0303	ACE-212-0303	ACE-213-0303	ACE-214-0303	ACE-215-0303
3.0 x 20	5	ACE-221-0203	ACE-222-0203	ACE-223-0203	ACE-224-0203	ACE-225-0203
3.0 x 20	3	ACE-211-0203	ACE-212-0203	ACE-213-0203	ACE-214-0203	ACE-215-0203
2.1 x 250	5	ACE-221-2502	ACE-222-2502	ACE-223-2502	ACE-224-2502	ACE-225-2502
2.1 x 150	5	ACE-221-1502	ACE-222-1502	ACE-223-1502	ACE-224-1502	ACE-225-1502
2.1 x 150	3	ACE-211-1502	ACE-212-1502	ACE-213-1502	ACE-214-1502	ACE-215-1502
2.1 x 100	5	ACE-221-1002	ACE-222-1002	ACE-223-1002	ACE-224-1002	ACE-225-1002
2.1 x 100	3	ACE-211-1002	ACE-212-1002	ACE-213-1002	ACE-214-1002	ACE-215-1002
2.1 x 75	5	ACE-221-7502	ACE-222-7502	ACE-223-7502	ACE-224-7502	ACE-225-7502
2.1 x 75	3	ACE-211-7502	ACE-212-7502	ACE-213-7502	ACE-214-7502	ACE-215-7502
2.1 x 50	5	ACE-221-0502	ACE-222-0502	ACE-223-0502	ACE-224-0502	ACE-225-0502
2.1 x 50	3	ACE-211-0502	ACE-212-0502	ACE-213-0502	ACE-214-0502	ACE-215-0502
2.1 x 30	5	ACE-221-0302	ACE-222-0302	ACE-223-0302	ACE-224-0302	ACE-225-0302
2.1 x 30	3	ACE-211-0302	ACE-212-0302	ACE-213-0302	ACE-214-0302	ACE-215-0302
2.1 x 20	5	ACE-221-0202	ACE-222-0202	ACE-223-0202	ACE-224-0202	ACE-225-0202
2.1 x 20	3	ACE-211-0202	ACE-212-0202	ACE-213-0202	ACE-214-0202	ACE-215-0202
1.0 x 250	5	ACE-221-2501	ACE-222-2501	ACE-223-2501	ACE-224-2501	ACE-225-2501
1.0 x 150	5	ACE-221-1501	ACE-222-1501	ACE-223-1501	ACE-224-1501	ACE-225-1501
1.0 x 150	3	ACE-211-1501	ACE-212-1501	ACE-213-1501	ACE-214-1501	ACE-215-1501
1.0 x 100	5	ACE-221-1001	ACE-222-1001	ACE-223-1001	ACE-224-1001	ACE-225-1001
1.0 x 100	3	ACE-211-1001	ACE-212-1001	ACE-213-1001	ACE-214-1001	ACE-215-1001
1.0 x 75	5	ACE-221-7501	ACE-222-7501	ACE-223-7501	ACE-224-7501	ACE-225-7501
1.0 x 75	3	ACE-211-7501	ACE-212-7501	ACE-213-7501	ACE-214-7501	ACE-215-7501
1.0 x 50	5	ACE-221-0501	ACE-222-0501	ACE-223-0501	ACE-224-0501	ACE-225-0501
1.0 x 50	3	ACE-211-0501	ACE-212-0501	ACE-213-0501	ACE-214-0501	ACE-215-0501

**ACE guard column cartridges for analytical columns 3.0 - 4.6 mm ID. Five guard cartridges per pack. Holder (H0005) required.**

Dimension (mm)	Particle Size (µm)	ACE C18-300	ACE C8-300	ACE C4-300	ACE CN-300	ACE Phenyl-300
For 3.0 - 4.6mm ID Columns	3	ACE-211-0103GD	ACE-212-0103GD	ACE-213-0103GD	ACE-214-0103GD	ACE-215-0103GD
For 3.0 - 4.6mm ID Columns	5	ACE-221-0103GD	ACE-222-0103GD	ACE-223-0103GD	ACE-224-0103GD	ACE-225-0103GD
Integral guard holder for above		H0005	H0005	H0005	H0005	H0005

The stand-alone guard cartridge holder should be used for all 20mm length columns.

**ACE guard column cartridges for narrow bore columns 2.1 mm ID. Five guard cartridges per pack. Holder (H0004) required.**

Dimension (mm)	Particle Size (µm)	ACE C18-300	ACE C8-300	ACE C4-300	ACE CN-300	ACE Phenyl-300
For 2.1mm ID Columns	3	ACE-211-0102GD	ACE-212-0102GD	ACE-213-0102GD	ACE-214-0102GD	ACE-215-0102GD
For 2.1mm ID Columns	5	ACE-221-0102GD	ACE-222-0102GD	ACE-223-0102GD	ACE-224-0102GD	ACE-225-0102GD
Integral guard holder for above		H0004	H0004	H0004	H0004	H0004

The stand-alone guard cartridge holder should be used for all 20mm length columns.

**ACE guard column cartridges for narrow bore columns 1.0 mm ID. Five guard cartridges per pack. Holder (H0001) and column coupler (C0001) required.**

Dimension (mm)	Particle Size (µm)	ACE C18-300	ACE C8-300	ACE C4-300	ACE CN-300	ACE Phenyl-300
For 1.0mm ID Columns	3	ACE-211-0101GD	ACE-212-0101GD	ACE-213-0101GD	ACE-214-0101GD	ACE-215-0101GD
For 1.0mm ID Columns	5	ACE-221-0101GD	ACE-222-0101GD	ACE-223-0101GD	ACE-224-0101GD	ACE-225-0101GD
Stand-alone guard holder for above		H0001	H0001	H0001	H0001	H0001

Note: A stand-alone guard cartridge holder is available for all the guard cartridges listed above. The part number for this guard cartridge holder is H0001. Connecting tubing and fittings, or a column coupler (part number C0001), is required to use this stand-alone guard cartridge holder.

Other dimensions are available. Please enquire for details.

**Part Numbers**

**ACE® 100Å Ultra-Inert Base Deactivated Capillary and Nano HPLC Columns**

Dimension (mm)	Particle Size (µm)	ACE C18	ACE C18-AR	ACE C18-PFP	ACE C8	ACE C4
0.075 x 250	5	ACE-121-2500075	ACE-129-2500075	ACE-1210-2500075	ACE-122-2500075	ACE-123-2500075
0.075 x 150	5	ACE-121-1500075	ACE-129-1500075	ACE-1210-1500075	ACE-122-1500075	ACE-123-1500075
0.075 x 150	3	ACE-111-1500075	ACE-119-1500075	ACE-1110-1500075	ACE-112-1500075	ACE-113-1500075
0.075 x 100	5	ACE-121-1000075	ACE-129-1000075	ACE-1210-1000075	ACE-122-1000075	ACE-123-1000075
0.075 x 100	3	ACE-111-1000075	ACE-119-1000075	ACE-1110-1000075	ACE-112-1000075	ACE-113-1000075
0.10 x 250	5	ACE-121-25001	ACE-129-25001	ACE-1210-25001	ACE-122-25001	ACE-123-25001
0.10 x 150	5	ACE-121-15001	ACE-129-15001	ACE-1210-15001	ACE-122-15001	ACE-123-15001
0.10 x 150	3	ACE-111-15001	ACE-119-15001	ACE-1110-15001	ACE-112-15001	ACE-113-15001
0.10 x 100	5	ACE-121-10001	ACE-129-10001	ACE-1210-10001	ACE-122-10001	ACE-123-10001
0.10 x 100	3	ACE-111-10001	ACE-119-10001	ACE-1110-10001	ACE-112-10001	ACE-113-10001
0.30 x 250	5	ACE-121-25003	ACE-129-25003	ACE-1210-25003	ACE-122-25003	ACE-123-25003
0.30 x 150	5	ACE-121-15003	ACE-129-15003	ACE-1210-15003	ACE-122-15003	ACE-123-15003
0.30 x 150	3	ACE-111-15003	ACE-119-15003	ACE-1110-15003	ACE-112-15003	ACE-113-15003
0.30 x 100	5	ACE-121-10003	ACE-129-10003	ACE-1210-10003	ACE-122-10003	ACE-123-10003
0.30 x 100	3	ACE-111-10003	ACE-119-10003	ACE-1110-10003	ACE-112-10003	ACE-113-10003
0.30 x 50	5	ACE-121-05003	ACE-129-05003	ACE-1210-05003	ACE-122-05003	ACE-123-05003
0.30 x 50	3	ACE-111-05003	ACE-119-05003	ACE-1110-05003	ACE-112-05003	ACE-113-05003
0.30 x 30	5	ACE-121-03003	ACE-129-03003	ACE-1210-03003	ACE-122-03003	ACE-123-03003
0.30 x 30	3	ACE-111-03003	ACE-119-03003	ACE-1110-03003	ACE-112-03003	ACE-113-03003
0.50 x 250	5	ACE-121-25005	ACE-129-25005	ACE-1210-25005	ACE-122-25005	ACE-123-25005
0.50 x 150	5	ACE-121-15005	ACE-129-15005	ACE-1210-15005	ACE-122-15005	ACE-123-15005
0.50 x 150	3	ACE-111-15005	ACE-119-15005	ACE-1110-15005	ACE-112-15005	ACE-113-15005
0.50 x 100	5	ACE-121-10005	ACE-129-10005	ACE-1210-10005	ACE-122-10005	ACE-123-10005
0.50 x 100	3	ACE-111-10005	ACE-119-10005	ACE-1110-10005	ACE-112-10005	ACE-113-10005
0.50 x 50	5	ACE-121-05005	ACE-129-05005	ACE-1210-05005	ACE-122-05005	ACE-123-05005
0.50 x 50	3	ACE-111-05005	ACE-119-05005	ACE-1110-05005	ACE-112-05005	ACE-113-05005
0.50 x 30	5	ACE-121-03005	ACE-129-03005	ACE-1210-03005	ACE-122-03005	ACE-123-03005
0.50 x 30	3	ACE-111-03005	ACE-119-03005	ACE-1110-03005	ACE-112-03005	ACE-113-03005

Other dimensions are available. Please enquire for details.

**ACE® 100Å Ultra-Inert Base Deactivated Capillary and Nano HPLC Columns (Continued)**

Dimension (mm)	Particle Size (µm)	ACE CN	ACE Phenyl	ACE AQ	ACE SIL	ACE C18-HL
0.075 x 250	5	ACE-124-2500075	ACE-125-2500075	ACE-126-2500075	ACE-127-2500075	ACE-321-2500075
0.075 x 150	5	ACE-124-1500075	ACE-125-1500075	ACE-126-1500075	ACE-127-1500075	ACE-321-1500075
0.075 x 150	3	ACE-114-1500075	ACE-115-1500075	ACE-116-1500075	ACE-117-1500075	ACE-311-1500075
0.075 x 100	5	ACE-124-1000075	ACE-125-1000075	ACE-126-1000075	ACE-127-1000075	ACE-321-1000075
0.075 x 100	3	ACE-114-1000075	ACE-115-1000075	ACE-116-1000075	ACE-117-1000075	ACE-311-1000075
0.10 x 250	5	ACE-124-25001	ACE-125-25001	ACE-126-25001	ACE-127-25001	ACE-321-25001
0.10 x 150	5	ACE-124-15001	ACE-125-15001	ACE-126-15001	ACE-127-15001	ACE-321-15001
0.10 x 150	3	ACE-114-15001	ACE-115-15001	ACE-116-15001	ACE-117-15001	ACE-311-15001
0.10 x 100	5	ACE-124-10001	ACE-125-10001	ACE-126-10001	ACE-127-10001	ACE-321-10001
0.10 x 100	3	ACE-114-10001	ACE-115-10001	ACE-116-10001	ACE-117-10001	ACE-311-10001
0.30 x 250	5	ACE-124-25003	ACE-125-25003	ACE-126-25003	ACE-127-25003	ACE-321-25003
0.30 x 150	5	ACE-124-15003	ACE-125-15003	ACE-126-15003	ACE-127-15003	ACE-321-15003
0.30 x 150	3	ACE-114-15003	ACE-115-15003	ACE-116-15003	ACE-117-15003	ACE-311-15003
0.30 x 100	5	ACE-124-10003	ACE-125-10003	ACE-126-10003	ACE-127-10003	ACE-321-10003
0.30 x 100	3	ACE-114-10003	ACE-115-10003	ACE-116-10003	ACE-117-10003	ACE-311-10003
0.30 x 50	5	ACE-124-05003	ACE-125-05003	ACE-126-05003	ACE-127-05003	ACE-321-05003
0.30 x 50	3	ACE-114-05003	ACE-115-05003	ACE-116-05003	ACE-117-05003	ACE-311-05003
0.30 x 30	5	ACE-124-03003	ACE-125-03003	ACE-126-03003	ACE-127-03003	ACE-321-03003
0.30 x 30	3	ACE-114-03003	ACE-115-03003	ACE-116-03003	ACE-117-03003	ACE-311-03003
0.50 x 250	5	ACE-124-25005	ACE-125-25005	ACE-126-25005	ACE-127-25005	ACE-321-25005
0.50 x 150	5	ACE-124-15005	ACE-125-15005	ACE-126-15005	ACE-127-15005	ACE-321-15005
0.50 x 150	3	ACE-114-15005	ACE-115-15005	ACE-116-15005	ACE-117-15005	ACE-311-15005
0.50 x 100	5	ACE-124-10005	ACE-125-10005	ACE-126-10005	ACE-127-10005	ACE-321-10005
0.50 x 100	3	ACE-114-10005	ACE-115-10005	ACE-116-10005	ACE-117-10005	ACE-311-10005
0.50 x 50	5	ACE-124-05005	ACE-125-05005	ACE-126-05005	ACE-127-05005	ACE-321-05005
0.50 x 50	3	ACE-114-05005	ACE-115-05005	ACE-116-05005	ACE-117-05005	ACE-311-05005
0.50 x 30	5	ACE-124-03005	ACE-125-03005	ACE-126-03005	ACE-127-03005	ACE-321-03005
0.50 x 30	3	ACE-114-03005	ACE-115-03005	ACE-116-03005	ACE-117-03005	ACE-311-03005

Other dimensions are available. Please enquire for details.

**Part Numbers**

**ACE® 300Å Ultra-Inert Base Deactivated Capillary and Nano HPLC Columns for Peptides/Proteins**

Dimension (mm)	Particle Size (µm)	ACE C18-300	ACE C8-300	ACE C4-300	ACE CN-300	ACE Phenyl-300
0.075 x 250	5	ACE-221-2500075	ACE-222-2500075	ACE-223-2500075	ACE-224-2500075	ACE-225-2500075
0.075 x 150	5	ACE-221-1500075	ACE-222-1500075	ACE-223-1500075	ACE-224-1500075	ACE-225-1500075
0.075 x 150	3	ACE-211-1500075	ACE-212-1500075	ACE-213-1500075	ACE-214-1500075	ACE-215-1500075
0.075 x 100	5	ACE-221-1000075	ACE-222-1000075	ACE-223-1000075	ACE-224-1000075	ACE-225-1000075
0.075 x 100	3	ACE-211-1000075	ACE-212-1000075	ACE-213-1000075	ACE-214-1000075	ACE-215-1000075
0.10 x 250	5	ACE-221-25001	ACE-222-25001	ACE-223-25001	ACE-224-25001	ACE-225-25001
0.10 x 150	5	ACE-221-15001	ACE-222-15001	ACE-223-15001	ACE-224-15001	ACE-225-15001
0.10 x 150	3	ACE-211-15001	ACE-212-15001	ACE-213-15001	ACE-214-15001	ACE-215-15001
0.10 x 100	5	ACE-221-10001	ACE-222-10001	ACE-223-10001	ACE-224-10001	ACE-225-10001
0.10 x 100	3	ACE-211-10001	ACE-212-10001	ACE-213-10001	ACE-214-10001	ACE-215-10001
0.30 x 250	5	ACE-221-25003	ACE-222-25003	ACE-223-25003	ACE-224-25003	ACE-225-25003
0.30 x 150	5	ACE-221-15003	ACE-222-15003	ACE-223-15003	ACE-224-15003	ACE-225-15003
0.30 x 150	3	ACE-211-15003	ACE-212-15003	ACE-213-15003	ACE-214-15003	ACE-215-15003
0.30 x 100	5	ACE-221-10003	ACE-222-10003	ACE-223-10003	ACE-224-10003	ACE-225-10003
0.30 x 100	3	ACE-211-10003	ACE-212-10003	ACE-213-10003	ACE-214-10003	ACE-215-10003
0.30 x 50	5	ACE-221-05003	ACE-222-05003	ACE-223-05003	ACE-224-05003	ACE-225-05003
0.30 x 50	3	ACE-211-05003	ACE-212-05003	ACE-213-05003	ACE-214-05003	ACE-215-05003
0.30 x 30	5	ACE-221-03003	ACE-222-03003	ACE-223-03003	ACE-224-03003	ACE-225-03003
0.30 x 30	3	ACE-211-03003	ACE-212-03003	ACE-213-03003	ACE-214-03003	ACE-215-03003
0.50 x 250	5	ACE-221-25005	ACE-222-25005	ACE-223-25005	ACE-224-25005	ACE-225-25005
0.50 x 150	5	ACE-221-15005	ACE-222-15005	ACE-223-15005	ACE-224-15005	ACE-225-15005
0.50 x 150	3	ACE-211-15005	ACE-212-15005	ACE-213-15005	ACE-214-15005	ACE-215-15005
0.50 x 100	5	ACE-221-10005	ACE-222-10005	ACE-223-10005	ACE-224-10005	ACE-225-10005
0.50 x 100	3	ACE-211-10005	ACE-212-10005	ACE-213-10005	ACE-214-10005	ACE-215-10005
0.50 x 50	5	ACE-221-05005	ACE-222-05005	ACE-223-05005	ACE-224-05005	ACE-225-05005
0.50 x 50	3	ACE-211-05005	ACE-212-05005	ACE-213-05005	ACE-214-05005	ACE-215-05005
0.50 x 30	5	ACE-221-03005	ACE-222-03005	ACE-223-03005	ACE-224-03005	ACE-225-03005
0.50 x 30	3	ACE-211-03005	ACE-212-03005	ACE-213-03005	ACE-214-03005	ACE-215-03005

*Other dimensions are available. Please enquire for details.*

Part Numbers

# ACE® 100Å Preparative Ultra-Inert Base Deactivated HPLC Columns

Dimension (mm)	Particle Size (µm)	ACE C18	ACE C18-AR	ACE C18-PFP	ACE C8	ACE C4
10.0 x 50	5	ACE-121-0510	ACE-129-0510	ACE-1210-0510	ACE-122-0510	ACE-123-0510
10.0 x 75	5	ACE-121-7510	ACE-129-7510	ACE-1210-7510	ACE-122-7510	ACE-123-7510
10.0 x 100	5	ACE-121-1010	ACE-129-1010	ACE-1210-1010	ACE-122-1010	ACE-123-1010
10.0 x 150	5	ACE-121-1510	ACE-129-1510	ACE-1210-1510	ACE-122-1510	ACE-123-1510
10.0 x 250	5	ACE-121-2510	ACE-129-2510	ACE-1210-2510	ACE-122-2510	ACE-123-2510
21.2 x 50	5	ACE-121-0520	ACE-129-0520	ACE-1210-0520	ACE-122-0520	ACE-123-0520
21.2 x 50	10	ACE-131-0520	ACE-139-0520	ACE-1310-0520	ACE-132-0520	ACE-133-0520
21.2 x 75	5	ACE-121-7520	ACE-129-7520	ACE-1210-7520	ACE-122-7520	ACE-123-7520
21.2 x 75	10	ACE-131-7520	ACE-139-7520	ACE-1310-7520	ACE-132-7520	ACE-133-7520
21.2 x 100	5	ACE-121-1020	ACE-129-1020	ACE-1210-1020	ACE-122-1020	ACE-123-1020
21.2 x 100	10	ACE-131-1020	ACE-139-1020	ACE-1310-1020	ACE-132-1020	ACE-133-1020
21.2 x 150	5	ACE-121-1520	ACE-129-1520	ACE-1210-1520	ACE-122-1520	ACE-123-1520
21.2 x 150	10	ACE-131-1520	ACE-139-1520	ACE-1310-1520	ACE-132-1520	ACE-133-1520
21.2 x 250	5	ACE-121-2520	ACE-129-2520	ACE-1210-2520	ACE-122-2520	ACE-123-2520
21.2 x 250	10	ACE-131-2520	ACE-139-2520	ACE-1310-2520	ACE-132-2520	ACE-133-2520
30.0 x 50	10	ACE-131-0530	ACE-139-0530	ACE-1310-0530	ACE-132-0530	ACE-133-0530
30.0 x 100	10	ACE-131-1030	ACE-139-1030	ACE-1310-1030	ACE-132-1030	ACE-133-1030
30.0 x 150	10	ACE-131-1530	ACE-139-1530	ACE-1310-1530	ACE-132-1530	ACE-133-1530
30.0 x 250	10	ACE-131-2530	ACE-139-2530	ACE-1310-2530	ACE-132-2530	ACE-133-2530

**ACE guard column cartridges for preparative columns 10.0 or 21.2 mm ID. Three guard cartridges per pack. Holder (H0002) and coupler (C0001) required.**

Dimension (mm)	Particle Size (µm)	ACE C18	ACE C18-AR	ACE C18-PFP	ACE C8	ACE C4
For 10 - 21.2mm ID Columns	5	ACE-121-0110GD	ACE-129-0110GD	ACE-1210-0110GD	ACE-122-0110GD	ACE-123-0110GD
For 10 - 21.2mm ID Columns	10	ACE-131-0110GD	ACE-139-0110GD	ACE-1310-0110GD	ACE-132-0110GD	ACE-133-0110GD
Guard holder for above		H0002	H0002	H0002	H0002	H0002

**ACE guard column cartridges for preparative columns 30.0 mm ID. A single guard cartridge. Holder (H0006) and coupler (C0002) required.**

Dimension (mm)	Particle Size (µm)	ACE C18	ACE C18-AR	ACE C18-PFP	ACE C8	ACE C4
For 30mm ID Columns	5	ACE-121-0220GD	ACE-129-0220GD	ACE-1210-0220GD	ACE-122-0220GD	ACE-123-0220GD
For 30mm ID Columns	10	ACE-131-0220GD	ACE-139-0220GD	ACE-1310-0220GD	ACE-132-0220GD	ACE-133-0220GD
Guard holder for above		H0006	H0006	H0006	H0006	H0006

Part Numbers

# ACE® 100Å Preparative Ultra-Inert Base Deactivated HPLC Columns (Continued)

Dimension (mm)	Particle Size (µm)	ACE CN	ACE Phenyl	ACE AQ	ACE SIL	ACEC18-HL
10.0 x 50	5	ACE-124-0510	ACE-125-0510	ACE-126-0510	ACE-127-0510	ACE-321-0510
10.0 x 75	5	ACE-124-7510	ACE-125-7510	ACE-126-7510	ACE-127-7510	ACE-321-7510
10.0 x 100	5	ACE-124-1010	ACE-125-1010	ACE-126-1010	ACE-127-1010	ACE-321-1010
10.0 x 150	5	ACE-124-1510	ACE-125-1510	ACE-126-1510	ACE-127-1510	ACE-321-1510
10.0 x 250	5	ACE-124-2510	ACE-125-2510	ACE-126-2510	ACE-127-2510	ACE-321-2510
21.2 x 50	5	ACE-124-0520	ACE-125-0520	ACE-126-0520	ACE-127-0520	ACE-321-0520
21.2 x 50	10	ACE-134-0520	ACE-135-0520	ACE-136-0520	ACE-137-0520	ACE-331-0520
21.2 x 75	5	ACE-124-7520	ACE-125-7520	ACE-126-7520	ACE-127-7520	ACE-321-7520
21.2 x 75	10	ACE-134-7520	ACE-135-7520	ACE-136-7520	ACE-137-7520	ACE-331-7520
21.2 x 100	5	ACE-124-1020	ACE-125-1020	ACE-126-1020	ACE-127-1020	ACE-321-1020
21.2 x 100	10	ACE-134-1020	ACE-135-1020	ACE-136-1020	ACE-137-1020	ACE-331-1020
21.2 x 150	5	ACE-124-1520	ACE-125-1520	ACE-126-1520	ACE-127-1520	ACE-321-1520
21.2 x 150	10	ACE-134-1520	ACE-135-1520	ACE-136-1520	ACE-137-1520	ACE-331-1520
21.2 x 250	5	ACE-124-2520	ACE-125-2520	ACE-126-2520	ACE-127-2520	ACE-321-2520
21.2 x 250	10	ACE-134-2520	ACE-135-2520	ACE-136-2520	ACE-137-2520	ACE-331-2520
30.0 x 50	10	ACE-134-0530	ACE-135-0530	ACE-136-0530	ACE-137-0530	ACE-331-0530
30.0 x 100	10	ACE-134-1030	ACE-135-1030	ACE-136-1030	ACE-137-1030	ACE-331-1030
30.0 x 150	10	ACE-134-1530	ACE-135-1530	ACE-136-1530	ACE-137-1530	ACE-331-1530
30.0 x 250	10	ACE-134-2530	ACE-135-2530	ACE-136-2530	ACE-137-2530	ACE-331-2530

**ACE guard column cartridges for preparative columns 10.0 or 21.2 mm ID. Three guard cartridges per pack. Holder (H0002) and coupler (C0001) required.**

Dimension (mm)	Particle Size (µm)	ACE CN	ACE Phenyl	ACE AQ	ACE SIL	ACEC18-HL
For 10 - 21.2mm ID Columns	5	ACE-124-0110GD	ACE-125-0110GD	ACE-126-0110GD	ACE-127-0110GD	ACE-321-0110GD
For 10 - 21.2mm ID Columns	10	ACE-134-0110GD	ACE-135-0110GD	ACE-136-0110GD	ACE-137-0110GD	ACE-331-0110GD
Guard holder for above		H0002	H0002	H0002	H0002	H0002

**ACE guard column cartridges for preparative columns 30.0 mm ID. A single guard cartridge. Holder (H0006) and coupler (C0002) required.**

Dimension (mm)	Particle Size (µm)	ACE CN	ACE Phenyl	ACE AQ	ACE SIL	ACEC18-HL
For 30mm ID Columns	5	ACE-124-0220GD	ACE-125-0220GD	ACE-126-0220GD	ACE-127-0220GD	ACE-321-0220GD
For 30mm ID Columns	10	ACE-134-0220GD	ACE-135-0220GD	ACE-136-0220GD	ACE-137-0220GD	ACE-331-0220GD
Guard holder for above		H0006	H0006	H0006	H0006	H0006

Other dimensions are available. Please enquire for details.

## Part Numbers

# ACE® 300Å Preparative Ultra-Inert Base Deactivated HPLC Columns for Peptides/Proteins

Dimension (mm)	Particle Size (µm)	ACE C18-300	ACE C8-300	ACE C4-300	ACE CN-300	ACE Phenyl-300
10.0 x 50	5	ACE-221-0510	ACE-222-0510	ACE-223-0510	ACE-224-0510	ACE-225-0510
10.0 x 75	5	ACE-221-7510	ACE-222-7510	ACE-223-7510	ACE-224-7510	ACE-225-7510
10.0 x 100	5	ACE-221-1010	ACE-222-1010	ACE-223-1010	ACE-224-1010	ACE-225-1010
10.0 x 150	5	ACE-221-1510	ACE-222-1510	ACE-223-1510	ACE-224-1510	ACE-225-1510
10.0 x 250	5	ACE-221-2510	ACE-222-2510	ACE-223-2510	ACE-224-2510	ACE-225-2510
21.2 x 50	5	ACE-221-0520	ACE-222-0520	ACE-223-0520	ACE-224-0520	ACE-225-0520
21.2 x 50	10	ACE-231-0520	ACE-232-0520	ACE-233-0520	ACE-234-0520	ACE-235-0520
21.2 x 75	5	ACE-221-7520	ACE-222-7520	ACE-223-7520	ACE-224-7520	ACE-225-7520
21.2 x 75	10	ACE-231-7520	ACE-232-7520	ACE-233-7520	ACE-234-7520	ACE-235-7520
21.2 x 100	5	ACE-221-1020	ACE-222-1020	ACE-223-1020	ACE-224-1020	ACE-225-1020
21.2 x 100	10	ACE-231-1020	ACE-232-1020	ACE-233-1020	ACE-234-1020	ACE-235-1020
21.2 x 150	5	ACE-221-1520	ACE-222-1520	ACE-223-1520	ACE-224-1520	ACE-225-1520
21.2 x 150	10	ACE-231-1520	ACE-232-1520	ACE-233-1520	ACE-234-1520	ACE-235-1520
21.2 x 250	5	ACE-221-2520	ACE-222-2520	ACE-223-2520	ACE-224-2520	ACE-225-2520
21.2 x 250	10	ACE-231-2520	ACE-232-2520	ACE-233-2520	ACE-234-2520	ACE-235-2520

### ACE guard column cartridges for preparative columns 10.0 or 21.2 mm ID. Three guard cartridges per pack. Holder (H0002) and coupler (C0001) required.

Dimension (mm)	Particle Size (µm)	ACE C18-300	ACE C8-300	ACE C4-300	ACE CN-300	ACE Phenyl-300
For 10 - 21.2mm ID Columns	5	ACE-221-0110GD	ACE-222-0110GD	ACE-223-0110GD	ACE-224-0110GD	ACE-225-0110GD
For 10 - 21.2mm ID Columns	10	ACE-231-0110GD	ACE-232-0110GD	ACE-233-0110GD	ACE-234-0110GD	ACE-235-0110GD
Guard holder for above		H0002	H0002	H0002	H0002	H0002

Other dimensions are available. Please enquire for details.

Part Numbers

# ACE<sup>®</sup> Excel<sup>™</sup> 2µm 100Å Ultra-Inert UHPLC Columns

Dimension (mm)	Particle Size (µm)	C18	C18-AR	C18-PFP	C8	C4	CN	Phenyl	AQ
100 x 2.1	2	EXL-101-1002U	EXL-109-1002U	EXL-1010-1002U	EXL-102-1002U	EXL-103-1002U	EXL-104-1002U	EXL-105-1002U	EXL-106-1002U
100 x 3.0	2	EXL-101-1003U	EXL-109-1003U	EXL-1010-1003U	EXL-102-1003U	EXL-103-1003U	EXL-104-1003U	EXL-105-1003U	EXL-106-1003U
100 x 4.6	2	EXL-101-1046U	EXL-109-1046U	EXL-1010-1046U	EXL-102-1046U	EXL-103-1046U	EXL-104-1046U	EXL-105-1046U	EXL-106-1046U
125 x 2.1	2	EXL-101-1202U	EXL-109-1202U	EXL-1010-1202U	EXL-102-1202U	EXL-103-1202U	EXL-104-1202U	EXL-105-1202U	EXL-106-1202U
125 x 3.0	2	EXL-101-1203U	EXL-109-1203U	EXL-1010-1203U	EXL-102-1203U	EXL-103-1203U	EXL-104-1203U	EXL-105-1203U	EXL-106-1203U
125 x 4.6	2	EXL-101-1246U	EXL-109-1246U	EXL-1010-1246U	EXL-102-1246U	EXL-103-1246U	EXL-104-1246U	EXL-105-1246U	EXL-106-1246U
150 x 2.1	2	EXL-101-1502U	EXL-109-1502U	EXL-1010-1502U	EXL-102-1502U	EXL-103-1502U	EXL-104-1502U	EXL-105-1502U	EXL-106-1502U
150 x 3.0	2	EXL-101-1503U	EXL-109-1503U	EXL-1010-1503U	EXL-102-1503U	EXL-103-1503U	EXL-104-1503U	EXL-105-1503U	EXL-106-1503U
150 x 4.6	2	EXL-101-1546U	EXL-109-1546U	EXL-1010-1546U	EXL-102-1546U	EXL-103-1546U	EXL-104-1546U	EXL-105-1546U	EXL-106-1546U
20 x 2.1	2	EXL-101-0202U	EXL-109-0202U	EXL-1010-0202U	EXL-102-0202U	EXL-103-0202U	EXL-104-0202U	EXL-105-0202U	EXL-106-0202U
20 x 3.0	2	EXL-101-0203U	EXL-109-0203U	EXL-1010-0203U	EXL-102-0203U	EXL-103-0203U	EXL-104-0203U	EXL-105-0203U	EXL-106-0203U
20 x 4.6	2	EXL-101-0246U	EXL-109-0246U	EXL-1010-0246U	EXL-102-0246U	EXL-103-0246U	EXL-104-0246U	EXL-105-0246U	EXL-106-0246U
30 x 2.1	2	EXL-101-0302U	EXL-109-0302U	EXL-1010-0302U	EXL-102-0302U	EXL-103-0302U	EXL-104-0302U	EXL-105-0302U	EXL-106-0302U
30 x 3.0	2	EXL-101-0303U	EXL-109-0303U	EXL-1010-0303U	EXL-102-0303U	EXL-103-0303U	EXL-104-0303U	EXL-105-0303U	EXL-106-0303U
30 x 4.6	2	EXL-101-0346U	EXL-109-0346U	EXL-1010-0346U	EXL-102-0346U	EXL-103-0346U	EXL-104-0346U	EXL-105-0346U	EXL-106-0346U
35 x 2.1	2	EXL-101-3502U	EXL-109-3502U	EXL-1010-3502U	EXL-102-3502U	EXL-103-3502U	EXL-104-3502U	EXL-105-3502U	EXL-106-3502U
35 x 3.0	2	EXL-101-3503U	EXL-109-3503U	EXL-1010-3503U	EXL-102-3503U	EXL-103-3503U	EXL-104-3503U	EXL-105-3503U	EXL-106-3503U
35 x 4.6	2	EXL-101-3546U	EXL-109-3546U	EXL-1010-3546U	EXL-102-3546U	EXL-103-3546U	EXL-104-3546U	EXL-105-3546U	EXL-106-3546U
50 x 2.1	2	EXL-101-0502U	EXL-109-0502U	EXL-1010-0502U	EXL-102-0502U	EXL-103-0502U	EXL-104-0502U	EXL-105-0502U	EXL-106-0502U
50 x 3.0	2	EXL-101-0503U	EXL-109-0503U	EXL-1010-0503U	EXL-102-0503U	EXL-103-0503U	EXL-104-0503U	EXL-105-0503U	EXL-106-0503U
50 x 4.6	2	EXL-101-0546U	EXL-109-0546U	EXL-1010-0546U	EXL-102-0546U	EXL-103-0546U	EXL-104-0546U	EXL-105-0546U	EXL-106-0546U
75 x 2.1	2	EXL-101-7502U	EXL-109-7502U	EXL-1010-7502U	EXL-102-7502U	EXL-103-7502U	EXL-104-7502U	EXL-105-7502U	EXL-106-7502U
75 x 3.0	2	EXL-101-7503U	EXL-109-7503U	EXL-1010-7503U	EXL-102-7503U	EXL-103-7503U	EXL-104-7503U	EXL-105-7503U	EXL-106-7503U
75 x 4.6	2	EXL-101-7546U	EXL-109-7546U	EXL-1010-7546U	EXL-102-7546U	EXL-103-7546U	EXL-104-7546U	EXL-105-7546U	EXL-106-7546U

Other dimensions are available. Please enquire for details.

Part Numbers

# ACE<sup>®</sup> Excel<sup>™</sup> 3µm 100Å Ultra-Inert UHPLC Compatible Columns

Dimension (mm)	Particle Size (µm)	C18	C18-AR	C18-PFP	C8	C4	CN	Phenyl	AQ
100 x 2.1	3	EXL-111-1002U	EXL-119-1002U	EXL-1110-1002U	EXL-112-1002U	EXL-113-1002U	EXL-114-1002U	EXL-115-1002U	EXL-116-1002U
100 x 3.0	3	EXL-111-1003U	EXL-119-1003U	EXL-1110-1003U	EXL-112-1003U	EXL-113-1003U	EXL-114-1003U	EXL-115-1003U	EXL-116-1003U
100 x 4.6	3	EXL-111-1046U	EXL-119-1046U	EXL-1110-1046U	EXL-112-1046U	EXL-113-1046U	EXL-114-1046U	EXL-115-1046U	EXL-116-1046U
125 x 2.1	3	EXL-111-1202U	EXL-119-1202U	EXL-1110-1202U	EXL-112-1202U	EXL-113-1202U	EXL-114-1202U	EXL-115-1202U	EXL-116-1202U
125 x 3.0	3	EXL-111-1203U	EXL-119-1203U	EXL-1110-1203U	EXL-112-1203U	EXL-113-1203U	EXL-114-1203U	EXL-115-1203U	EXL-116-1203U
125 x 4.6	3	EXL-111-1246U	EXL-119-1246U	EXL-1110-1246U	EXL-112-1246U	EXL-113-1246U	EXL-114-1246U	EXL-115-1246U	EXL-116-1246U
150 x 2.1	3	EXL-111-1502U	EXL-119-1502U	EXL-1110-1502U	EXL-112-1502U	EXL-113-1502U	EXL-114-1502U	EXL-115-1502U	EXL-116-1502U
150 x 3.0	3	EXL-111-1503U	EXL-119-1503U	EXL-1110-1503U	EXL-112-1503U	EXL-113-1503U	EXL-114-1503U	EXL-115-1503U	EXL-116-1503U
150 x 4.6	3	EXL-111-1546U	EXL-119-1546U	EXL-1110-1546U	EXL-112-1546U	EXL-113-1546U	EXL-114-1546U	EXL-115-1546U	EXL-116-1546U
20 x 2.1	3	EXL-111-0202U	EXL-119-0202U	EXL-1110-0202U	EXL-112-0202U	EXL-113-0202U	EXL-114-0202U	EXL-115-0202U	EXL-116-0202U
20 x 3.0	3	EXL-111-0203U	EXL-119-0203U	EXL-1110-0203U	EXL-112-0203U	EXL-113-0203U	EXL-114-0203U	EXL-115-0203U	EXL-116-0203U
20 x 4.6	3	EXL-111-0246U	EXL-119-0246U	EXL-1110-0246U	EXL-112-0246U	EXL-113-0246U	EXL-114-0246U	EXL-115-0246U	EXL-116-0246U
250 x 2.1	3	EXL-111-2502U	EXL-119-2502U	EXL-1110-2502U	EXL-112-2502U	EXL-113-2502U	EXL-114-2502U	EXL-115-2502U	EXL-116-2502U
250 x 3.0	3	EXL-111-2503U	EXL-119-2503U	EXL-1110-2503U	EXL-112-2503U	EXL-113-2503U	EXL-114-2503U	EXL-115-2503U	EXL-116-2503U
250 x 4.6	3	EXL-111-2546U	EXL-119-2546U	EXL-1110-2546U	EXL-112-2546U	EXL-113-2546U	EXL-114-2546U	EXL-115-2546U	EXL-116-2546U
30 x 2.1	3	EXL-111-0302U	EXL-119-0302U	EXL-1110-0302U	EXL-112-0302U	EXL-113-0302U	EXL-114-0302U	EXL-115-0302U	EXL-116-0302U
30 x 3.0	3	EXL-111-0303U	EXL-119-0303U	EXL-1110-0303U	EXL-112-0303U	EXL-113-0303U	EXL-114-0303U	EXL-115-0303U	EXL-116-0303U
30 x 4.6	3	EXL-111-0346U	EXL-119-0346U	EXL-1110-0346U	EXL-112-0346U	EXL-113-0346U	EXL-114-0346U	EXL-115-0346U	EXL-116-0346U
35 x 2.1	3	EXL-111-3502U	EXL-119-3502U	EXL-1110-3502U	EXL-112-3502U	EXL-113-3502U	EXL-114-3502U	EXL-115-3502U	EXL-116-3502U
35 x 3.0	3	EXL-111-3503U	EXL-119-3503U	EXL-1110-3503U	EXL-112-3503U	EXL-113-3503U	EXL-114-3503U	EXL-115-3503U	EXL-116-3503U
35 x 4.6	3	EXL-111-3546U	EXL-119-3546U	EXL-1110-3546U	EXL-112-3546U	EXL-113-3546U	EXL-114-3546U	EXL-115-3546U	EXL-116-3546U
50 x 2.1	3	EXL-111-0502U	EXL-119-0502U	EXL-1110-0502U	EXL-112-0502U	EXL-113-0502U	EXL-114-0502U	EXL-115-0502U	EXL-116-0502U
50 x 3.0	3	EXL-111-0503U	EXL-119-0503U	EXL-1110-0503U	EXL-112-0503U	EXL-113-0503U	EXL-114-0503U	EXL-115-0503U	EXL-116-0503U
50 x 4.6	3	EXL-111-0546U	EXL-119-0546U	EXL-1110-0546U	EXL-112-0546U	EXL-113-0546U	EXL-114-0546U	EXL-115-0546U	EXL-116-0546U
75 x 2.1	3	EXL-111-7502U	EXL-119-7502U	EXL-1110-7502U	EXL-112-7502U	EXL-113-7502U	EXL-114-7502U	EXL-115-7502U	EXL-116-7502U
75 x 3.0	3	EXL-111-7503U	EXL-119-7503U	EXL-1110-7503U	EXL-112-7503U	EXL-113-7503U	EXL-114-7503U	EXL-115-7503U	EXL-116-7503U
75 x 4.6	3	EXL-111-7546U	EXL-119-7546U	EXL-1110-7546U	EXL-112-7546U	EXL-113-7546U	EXL-114-7546U	EXL-115-7546U	EXL-116-7546U

Other dimensions are available. Please enquire for details.

## Part Numbers

# ACE® Excel™ 5µm 100Å Ultra-Inert UHPLC Compatible Columns

Dimension (mm)	Particle Size (µm)	C18	C18-AR	C18-PFP	C8	C4	CN	Phenyl	AQ
100 x 2.1	5	EXL-121-1002U	EXL-129-1002U	EXL-1210-1002U	EXL-122-1002U	EXL-123-1002U	EXL-124-1002U	EXL-125-1002U	EXL-126-1002U
100 x 3.0	5	EXL-121-1003U	EXL-129-1003U	EXL-1210-1003U	EXL-122-1003U	EXL-123-1003U	EXL-124-1003U	EXL-125-1003U	EXL-126-1003U
100 x 4.6	5	EXL-121-1046U	EXL-129-1046U	EXL-1210-1046U	EXL-122-1046U	EXL-123-1046U	EXL-124-1046U	EXL-125-1046U	EXL-126-1046U
125 x 2.1	5	EXL-121-1202U	EXL-129-1202U	EXL-1210-1202U	EXL-122-1202U	EXL-123-1202U	EXL-124-1202U	EXL-125-1202U	EXL-126-1202U
125 x 3.0	5	EXL-121-1203U	EXL-129-1203U	EXL-1210-1203U	EXL-122-1203U	EXL-123-1203U	EXL-124-1203U	EXL-125-1203U	EXL-126-1203U
125 x 4.6	5	EXL-121-1246U	EXL-129-1246U	EXL-1210-1246U	EXL-122-1246U	EXL-123-1246U	EXL-124-1246U	EXL-125-1246U	EXL-126-1246U
150 x 2.1	5	EXL-121-1502U	EXL-129-1502U	EXL-1210-1502U	EXL-122-1502U	EXL-123-1502U	EXL-124-1502U	EXL-125-1502U	EXL-126-1502U
150 x 3.0	5	EXL-121-1503U	EXL-129-1503U	EXL-1210-1503U	EXL-122-1503U	EXL-123-1503U	EXL-124-1503U	EXL-125-1503U	EXL-126-1503U
150 x 4.6	5	EXL-121-1546U	EXL-129-1546U	EXL-1210-1546U	EXL-122-1546U	EXL-123-1546U	EXL-124-1546U	EXL-125-1546U	EXL-126-1546U
20 x 2.1	5	EXL-121-0202U	EXL-129-0202U	EXL-1210-0202U	EXL-122-0202U	EXL-123-0202U	EXL-124-0202U	EXL-125-0202U	EXL-126-0202U
20 x 3.0	5	EXL-121-0203U	EXL-129-0203U	EXL-1210-0203U	EXL-122-0203U	EXL-123-0203U	EXL-124-0203U	EXL-125-0203U	EXL-126-0203U
20 x 4.6	5	EXL-121-0246U	EXL-129-0246U	EXL-1210-0246U	EXL-122-0246U	EXL-123-0246U	EXL-124-0246U	EXL-125-0246U	EXL-126-0246U
250 x 2.1	5	EXL-121-2502U	EXL-129-2502U	EXL-1210-2502U	EXL-122-2502U	EXL-123-2502U	EXL-124-2502U	EXL-125-2502U	EXL-126-2502U
250 x 3.0	5	EXL-121-2503U	EXL-129-2503U	EXL-1210-2503U	EXL-122-2503U	EXL-123-2503U	EXL-124-2503U	EXL-125-2503U	EXL-126-2503U
250 x 4.6	5	EXL-121-2546U	EXL-129-2546U	EXL-1210-2546U	EXL-122-2546U	EXL-123-2546U	EXL-124-2546U	EXL-125-2546U	EXL-126-2546U
300 x 2.1	5	EXL-121-3002U	EXL-129-3002U	EXL-1210-3002U	EXL-122-3002U	EXL-123-3002U	EXL-124-3002U	EXL-125-3002U	EXL-126-3002U
300 x 3.0	5	EXL-121-3003U	EXL-129-3003U	EXL-1210-3003U	EXL-122-3003U	EXL-123-3003U	EXL-124-3003U	EXL-125-3003U	EXL-126-3003U
300 x 4.6	5	EXL-121-3046U	EXL-129-3046U	EXL-1210-3046U	EXL-122-3046U	EXL-123-3046U	EXL-124-3046U	EXL-125-3046U	EXL-126-3046U
30 x 2.1	5	EXL-121-0302U	EXL-129-0302U	EXL-1210-0302U	EXL-122-0302U	EXL-123-0302U	EXL-124-0302U	EXL-125-0302U	EXL-126-0302U
30 x 3.0	5	EXL-121-0303U	EXL-129-0303U	EXL-1210-0303U	EXL-122-0303U	EXL-123-0303U	EXL-124-0303U	EXL-125-0303U	EXL-126-0303U
30 x 4.6	5	EXL-121-0346U	EXL-129-0346U	EXL-1210-0346U	EXL-122-0346U	EXL-123-0346U	EXL-124-0346U	EXL-125-0346U	EXL-126-0346U
35 x 2.1	5	EXL-121-3502U	EXL-129-3502U	EXL-1210-3502U	EXL-122-3502U	EXL-123-3502U	EXL-124-3502U	EXL-125-3502U	EXL-126-3502U
35 x 3.0	5	EXL-121-3503U	EXL-129-3503U	EXL-1210-3503U	EXL-122-3503U	EXL-123-3503U	EXL-124-3503U	EXL-125-3503U	EXL-126-3503U
35 x 4.6	5	EXL-121-3546U	EXL-129-3546U	EXL-1210-3546U	EXL-122-3546U	EXL-123-3546U	EXL-124-3546U	EXL-125-3546U	EXL-126-3546U
50 x 2.1	5	EXL-121-0502U	EXL-129-0502U	EXL-1210-0502U	EXL-122-0502U	EXL-123-0502U	EXL-124-0502U	EXL-125-0502U	EXL-126-0502U
50 x 3.0	5	EXL-121-0503U	EXL-129-0503U	EXL-1210-0503U	EXL-122-0503U	EXL-123-0503U	EXL-124-0503U	EXL-125-0503U	EXL-126-0503U
50 x 4.6	5	EXL-121-0546U	EXL-129-0546U	EXL-1210-0546U	EXL-122-0546U	EXL-123-0546U	EXL-124-0546U	EXL-125-0546U	EXL-126-0546U
75 x 2.1	5	EXL-121-7502U	EXL-129-7502U	EXL-1210-7502U	EXL-122-7502U	EXL-123-7502U	EXL-124-7502U	EXL-125-7502U	EXL-126-7502U
75 x 3.0	5	EXL-121-7503U	EXL-129-7503U	EXL-1210-7503U	EXL-122-7503U	EXL-123-7503U	EXL-124-7503U	EXL-125-7503U	EXL-126-7503U
75 x 4.6	5	EXL-121-7546U	EXL-129-7546U	EXL-1210-7546U	EXL-122-7546U	EXL-123-7546U	EXL-124-7546U	EXL-125-7546U	EXL-126-7546U

Other dimensions are available. Please enquire for details.

## ACE® UHPLC Reusable Column Connector

**Pressure rating >1700bar (>25000psi)**

**Compatible with all UHPLC systems**

**Compatible with all UHPLC column brands**

**Eliminates Poor Connections**

**Innovative Reusable Design**

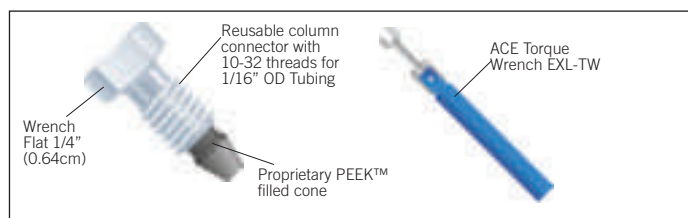

**For further information and to receive a FREE product bulletin, please contact your local distributor**

All UHPLC column brands require correct installation in order to realise maximum column efficiency. To avoid problems, the use of permanently swaged fittings is not recommended, as these do not allow free movement between the tubing, fitting and column inlet on installation. This can result in a poorly connected column that shows unexpected peak tailing due to the introduction of extra column volume (dead volume) to the system. Alternatively, a leak at the inlet fitting connection may be observed.

ACE UHPLC Column Connectors (p/n EXL-CC) are reusable and enable UHPLC columns to be correctly installed every time. Their unique design ensures that they maintain pressure rating with repeated use, yet do not permanently swage onto the inlet tubing. To maximize the lifetime of the fitting, the use of an ACE Torque Wrench (p/n EXL-TW) is required.

Standard ACE HPLC PEEK finger-tight connectors (p/n ACE-FT, pressure rated to 350bar/5000psi) may be used at the outlet end of the UHPLC column, where pressure demands are lower but a correct connection remains important.



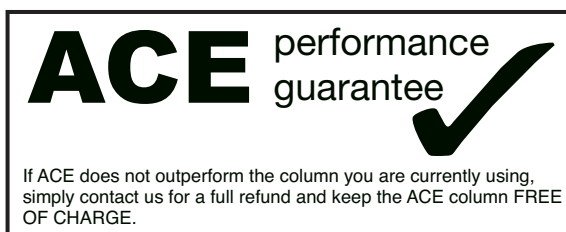

ACE® is a registered trademark of Advanced Chromatography Technologies Limited. ACE Excel™ and HSC™ are trademarks of Advanced Chromatography Technologies Limited.

Advanced Chromatography Technologies Limited acknowledges the registered and unregistered trademarks of Advanced Scientific Instruments, Agilent Technologies Inc., Alltech Associates Inc., G L Sciences Inc., Idex Health & Science LLC, Phenomenex Inc., Shimadzu Corporation, Thermo Fisher Scientific and Waters Corporation and has no affiliation with any of these companies.



ACE HPLC & UHPLC Columns offer unparalleled performance, excellent peak shape and guaranteed reproducibility, making ACE the finest columns available in today's market. ACE columns are available in nine bonded phases each offering a unique, and in some cases, dramatically different selectivity.

# ACE<sup>®</sup>

## FREE HPLC Technical Guides and Slide Chart

To receive your **FREE HPLC Technical Guides** or the **HPLC Column Slide Chart**, contact your local distributor or email: [info@ace-hplc.com](mailto:info@ace-hplc.com)



### **HPLC Column Slide Charts**

An ideal quick reference guide that contains a wealth of information for the liquid chromatographer. Please contact your local distributor for your free chart.

**ACE<sup>®</sup> Products are available through our international network of distributors [www.ace-hplc.com](http://www.ace-hplc.com)**

Advanced Chromatography Technologies Ltd, 1 Berry Street, Aberdeen, AB25 1HF, Scotland  
Tel : +44 (0) 1224 704 554 • Fax: +44 (0) 1224 841 301 • [www.ace-hplc.com](http://www.ace-hplc.com) • email: [info@ace-hplc.com](mailto:info@ace-hplc.com)

# ACE<sup>®</sup>

ACE<sup>®</sup> Products are available through  
our international network of distributors



[www.ace-hplc.com](http://www.ace-hplc.com)



**ACE<sup>®</sup>**

Advanced Chromatography Technologies Ltd, 1 Berry Street, Aberdeen, AB25 1HF, Scotland  
Tel : +44 (0) 1224 704 554 • Fax: +44 (0) 1224 841 301 • [www.ace-hplc.com](http://www.ace-hplc.com) • email: [info@ace-hplc.com](mailto:info@ace-hplc.com)